





Cono

Fin. 97 - Ø16

Acciaio satinato
Satin stainless steel
Acier satiné

Stahl satiniert matt
Acero satinado
Stal satynowy



Ogiva

Fin. 98 - Ø16

Acciaio lucido
Bright stainless steel
Acier poli

Stahl poliert
Acero pulido
Stal polerowana



Cilindro

Fin. 97 - Ø20

Acciaio satinato
Satin stainless steel
Acier satiné

Stahl satiniert matt
Acero satinado
Stal satynowy



Lancia

Fin. 98 - Ø20

Acciaio lucido
Bright stainless steel
Acier poli

Stahl poliert
Acero pulido
Stal polerowana

VENUS CONO

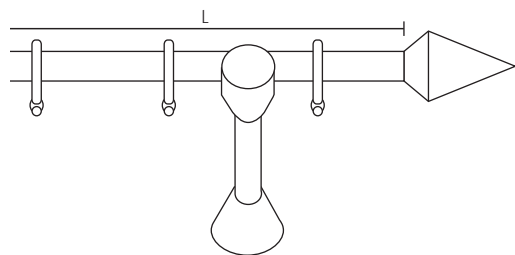

Scorritenda completo a parete
Complete curtain set
Tringle complète pose murale
Komplette Wandgarnitur
Conjunto completo a pared
Karnisz kompletny montaż do ściany

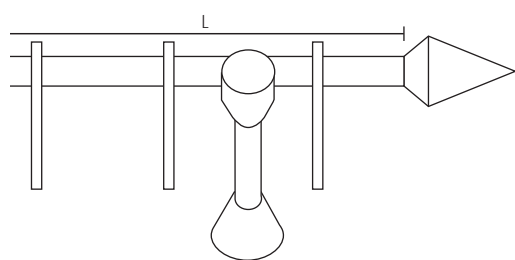

Scorritenda completo a parete
Complete curtain set
Tringle complète pose murale
Komplette Wandgarnitur
Conjunto completo a pared
Karnisz kompletny montaż do ściany

FIN. = Finitura - Finish - Finition - Fertigung - Acabado - Wykonczenie
An. = Anelli - Rings - Anneaux - Ringe - Anillas - Kółka
Pin. = Pinze - Clips - Pincas - Clips - Pinzas - Żabki
Sup. = Supporti - Brackets - Supports - Träger - Soportes - Wsporniki

Cod. 124A52		Ø 12 mm						
FIN	cm	120	140	160	180	200	220	250
97								
98								
An. Cod. 524005	n.	12	14	16	18	20	22	26
Sup. cm 6 - 16	n.	2	2	2	2	3	3	3

Cod. 164A52		Ø 16 mm								
FIN	cm	120	140	160	180	200	220	250	300	340
97										
98										
An. Cod. 524006	n.	12	14	16	18	20	22	26	30	34
Sup. cm 6 - 16	n.	2	2	2	2	2	3	3	3	3

Cod. 124J52		Ø 12 mm						
FIN	cm	120	140	160	180	200	220	250
97								
98								
Pin. Cod. 524037	n.	12	14	16	18	20	22	26
Sup. cm 6 - 16	n.	2	2	2	2	3	3	3

Cod. 164J52		Ø 16 mm								
FIN	cm	120	140	160	180	200	220	250	300	340
97										
98										
Pin. Cod. 524037	n.	12	14	16	18	20	22	26	30	34
Sup. cm 6 - 16	n.	2	2	2	2	2	3	3	3	3

VENUS CONO

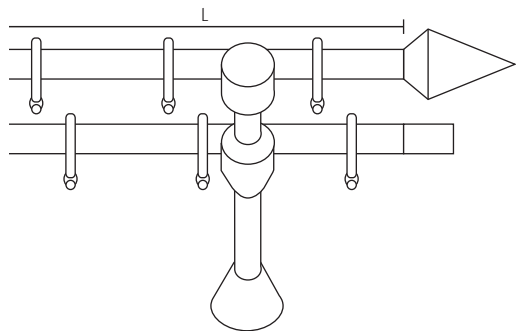

Scorritenda completo doppio a parete
 Complete double curtain set
 Tringle complète double
 Komplette doppelgarnitur
 Conjunto completo doble
 Karnisz podwójny kompletny montaż do ściany

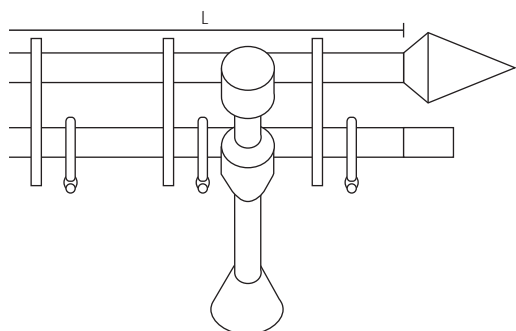

Scorritenda completo doppio a parete
 Complete double curtain set
 Tringle complète double
 Komplette doppelgarnitur
 Conjunto completo doble
 Karnisz podwójny kompletny montaż do ściany

FIN. = Finitura - Finish - Finition - Fertigung - Acabado - Wykonczenie
 An. = Anelli - Rings - Anneaux - Ringe - Anillas - Kółka
 Pin. = Pinze - Clips - Pince - Clips - Pinzas - Żabki
 Sup. = Supporti - Brackets - Supports - Träger - Soportes - Wsporniki

Cod. 124C52		Ø 12/12 mm						
FIN	cm	120	140	160	180	200	220	250
97								
98								
An. Cod. 524005	n.	12/12	14/14	16/16	18/18	20/20	22/22	26/26
Sup. cm 6 - 16	n.	2	2	2	2	3	3	3

Cod. 164C52		Ø 16/16 mm								
FIN	cm	120	140	160	180	200	220	250	300	340
97										
98										
An. Cod. 524006	n.	12/12	14/14	16/16	18/18	20/20	22/22	26/26	30/30	34/34
Sup. cm 6 - 16	n.	2	2	2	2	2	3	3	3	3

Cod. 124K52		Ø 12/12 mm						
FIN	cm	120	140	160	180	200	220	250
97								
98								
Pin. / An.								
Cod. 524037 - 524005	n.	12/12	14/14	16/16	18/18	20/20	22/22	26/26
Sup. cm 6 - 16	n.	2	2	2	2	3	3	3

Cod. 164K52		Ø 16/16 mm								
FIN	cm	120	140	160	180	200	220	250	300	340
97										
98										
Pin. / An.										
Cod. 524037 - 524006	n.	12/12	14/14	16/16	18/18	20/20	22/22	26/26	30/30	34/34
Sup. cm 6 - 16	n.	2	2	2	2	2	3	3	3	3

VENUS OGIVA

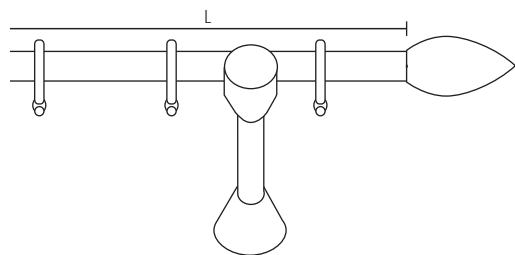

Scorritenda completo a parete
Complete curtain set
Tringle complète pose murale
Komplette Wandgarnitur
Conjunto completo a pared
Karnisz kompletny montaż do ściany

FIN. = Finitura - Finish - Finition - Fertigung - Acabado - Wykonczenie
An. = Anelli - Rings - Anneaux - Ringe - Anillas - Kółka
Pin. = Pinze - Clips - Pincas - Clips - Pinzas - Żabki
Gan. = Ganci - Hooks - Crochets - Rollenhaken - Ganchos - Haczyki
Sup. = Supporti - Brackets - Supports - Träger - Soportes - Wsporniki

Cod. 124A54		Ø 12 mm						
FIN	cm	120	140	160	180	200	220	250
97								
98								
An. Cod. 524005	n.	12	14	16	18	20	22	26
Sup. cm 6 - 16	n.	2	2	2	2	3	3	3

Cod. 164A54		Ø 16 mm								
FIN	cm	120	140	160	180	200	220	250	300	340
97										
98										
An. Cod. 524006	n.	12	14	16	18	20	22	26	30	34
Sup. cm 6 - 16	n.	2	2	2	2	2	3	3	3	3

Cod. 204A54		Ø 20 mm								
FIN	cm	120	140	160	180	200	220	250	300	340
97										
98										
An. Cod. 524006	n.	12	14	16	18	20	22	26	30	34
Sup. cm 6 - 16	n.	2	2	2	2	2	3	3	3	3

Cod. 204P54		Ø 20 mm								
FIN	cm	120	140	160	180	200	220	250	300	340
97										
98										
Pin. Cod. 524014	n.	12	14	16	18	20	22	26	30	34
Sup. cm 6 - 16	n.	2	2	2	2	2	3	3	3	3

Cod. 204E54		Ø 20 mm								
FIN	cm	120	140	160	180	200	220	250	300	340
97										
98										
Gan. Cod. 524008	n.	12	14	16	18	20	22	26	30	34
Sup. cm 6 - 16	n.	2	2	2	2	2	3*	3*	3*	3*

* Supporto intermedio Cod. 204119 - Central bracket Cod. 204119 - Supp. intermédiaire Cod. 204119
Mittelträger Cod. 204119 - Soporte intermedio Cod. 204119 - Wspornik środkowy Cod. 204119

Cod. 204H54		Ø 20 mm								
FIN	cm	120	140	160	180	200	220	250	300	340
97										
98										
Gan. Cod. 524009	n.	12	14	16	18	20	22	26	30	34
Sup. cm 6 - 16	n.	2	2	2	2	2	3*	3*	3*	3*

* Supporto intermedio Cod. 204119 - Central bracket Cod. 204119 - Supp. intermédiaire Cod. 204119
Mittelträger Cod. 204119 - Soporte intermedio Cod. 204119 - Wspornik środkowy Cod. 204119

Maggiorazione movimento a corda - Surcharge for corded systems - Supplément pour tirage
Zuschlag für Schnurbedienung - Suplemento por cuerda - Dodatkowo koszt mechanizmu

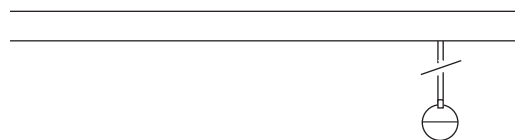

		Ø 20 mm								
	cm	120	140	160	180	200	220	250	300	340

VENUS OGIVA

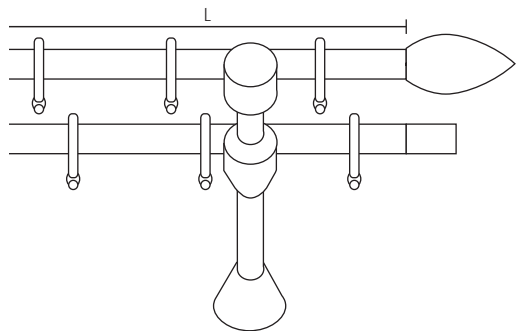

Scorritenda completo doppio a parete
 Complete double curtain set
 Tringle complète double
 Komplette doppelgarnitur
 Conjunto completo doble
 Karnisz podwójny kompletny montaż do ściany

FIN. = Finitura - Finish - Finition - Fertigung - Acabado - Wykonczenie
 An. = Anelli - Rings - Anneaux - Ringe - Anillas - Kółka
 Pin. = Pinze - Clips - Pinces - Clips - Pinzas - Żabki
 Gan. = Ganci - Hooks - Crochets - Rollenhaken - Ganchos - Haczyki
 Sup. = Supporti - Brackets - Supports - Träger - Soportes - Wsporniki

Cod. 124C54		Ø 12/12 mm						
FIN	cm	120	140	160	180	200	220	250
97								
98								
An. Cod. 524005	n.	12/12	14/14	16/16	18/18	20/20	22/22	26/26
Sup. cm 6 - 16	n.	2	2	2	2	3	3	3

Cod. 164C54		Ø 16/16 mm								
FIN	cm	120	140	160	180	200	220	250	300	340
97										
98										
An. Cod. 524006	n.	12/12	14/14	16/16	18/18	20/20	22/22	26/26	30/30	34/34
Sup. cm 6 - 16	n.	2	2	2	2	2	3	3	3	3

Cod. 204B54		Ø 20/20 mm								
FIN	cm	120	140	160	180	200	220	250	300	340
97										
98										
An. Cod. 524006	n.	12/12	14/14	16/16	18/18	20/20	22/22	26/26	30/30	34/34
Sup. cm 6 - 16	n.	2	2	2	2	2	3	3	3	3

Cod. 204N54		Ø 20/20 mm								
FIN	cm	120	140	160	180	200	220	250	300	340
97										
98										
Pin. Cod. 524014	n.	12/12	14/14	16/16	18/18	20/20	22/22	26/26	30/30	34/34
Sup. cm 6 - 16	n.	2	2	2	2	2	3	3	3	3

Cod. 204R54		Ø 20/20 mm								
FIN	cm	120	140	160	180	200	220	250	300	340
97										
98										
Gan. Cod. 524008	n.	12/12	14/14	16/16	18/18	20/20	22/22	26/26	30/30	34/34
Sup. cm 6 - 16	n.	2	2	2	2	2	3	3	3	3

Cod. 204S54		Ø 20/20 mm								
FIN	cm	120	140	160	180	200	220	250	300	340
97										
98										
Gan. Cod. 524009	n.	12/12	14/14	16/16	18/18	20/20	22/22	26/26	30/30	34/34
Sup. cm 6 - 16	n.	2	2	2	2	2	3	3	3	3

Cod. 204M54		Ø 20/20 mm								
FIN	cm	120	140	160	180	200	220	250	300	340
97										
98										
Pin / An.										
Cod. 524014 - 524006	n.	12/12	14/14	16/16	18/18	20/20	22/22	26/26	30/30	34/34
Sup. cm 6 - 16	n.	2	2	2	2	2	3	3	3	3

VENUS CILINDRO

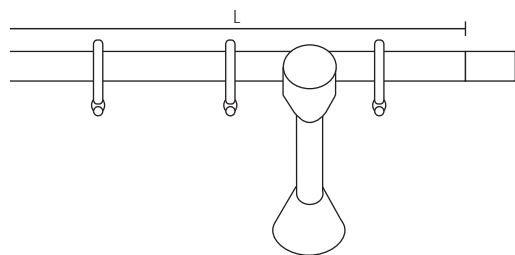

Scorritenda completo a parete
Complete curtain set
Tringle complète pose murale
Komplette Wandgarnitur
Conjunto completo a pared
Karnisz kompletny montaż do ściany

FIN. = Finitura - Finish - Finition - Fertigung - Acabado - Wykonczenie
An. = Anelli - Rings - Anneaux - Ringe - Anillas - Kółka
Pin. = Pinze - Clips - Pincas - Clips - Pinzas - Żabki
Gan. = Ganci - Hooks - Crochets - Rollenhaken - Ganchos - Haczyki
Sup. = Supporti - Brackets - Supports - Träger - Soportes - Wsporniki

Cod. 124A51		Ø 12 mm						
FIN	cm	120	140	160	180	200	220	250
97								
98								
An. Cod. 524005	n.	12	14	16	18	20	22	26
Sup. cm 6 - 16	n.	2	2	2	2	3	3	3

Cod. 164A51		Ø 16 mm								
FIN	cm	120	140	160	180	200	220	250	300	340
97										
98										
An. Cod. 524006	n.	12	14	16	18	20	22	26	30	34
Sup. cm 6 - 16	n.	2	2	2	2	2	3	3	3	3

Cod. 204A51		Ø 20 mm								
FIN	cm	120	140	160	180	200	220	250	300	340
97										
98										
An. Cod. 524006	n.	12	14	16	18	20	22	26	30	34
Sup. cm 6 - 16	n.	2	2	2	2	2	3	3	3	3

Cod. 204P51		Ø 20 mm								
FIN	cm	120	140	160	180	200	220	250	300	340
97										
98										
Pin. Cod. 524014	n.	12	14	16	18	20	22	26	30	34
Sup. cm 6 - 16	n.	2	2	2	2	2	3	3	3	3

Cod. 204E51		Ø 20 mm								
FIN	cm	120	140	160	180	200	220	250	300	340
97										
98										
Gan. Cod. 524008	n.	12	14	16	18	20	22	26	30	34
Sup. cm 6 - 16	n.	2	2	2	2	2	3*	3*	3*	3*

* Supporto intermedio Cod. 204119 - Central bracket Cod. 204119 - Supp. intermédiaire Cod. 204119
Mittelträger Cod. 204119 - Soporte intermedio Cod. 204119 - Wspornik środkowy Cod. 204119

Cod. 204H51		Ø 20 mm								
FIN	cm	120	140	160	180	200	220	250	300	340
97										
98										
Gan. Cod. 524009	n.	12	14	16	18	20	22	26	30	34
Sup. cm 6 - 16	n.	2	2	2	2	2	3*	3*	3*	3*

* Supporto intermedio Cod. 204119 - Central bracket Cod. 204119 - Supp. intermédiaire Cod. 204119
Mittelträger Cod. 204119 - Soporte intermedio Cod. 204119 - Wspornik środkowy Cod. 204119

Maggiorazione movimento a corda - Surcharge for corded systems - Supplément pour tirage
Zuschlag für Schnurbedienung - Suplemento por cuerda - Dodatkowo koszt mechanizmu

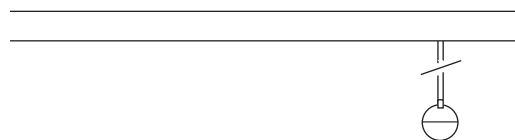

		Ø 20 mm								
	cm	120	140	160	180	200	220	250	300	340

VENUS CILINDRO

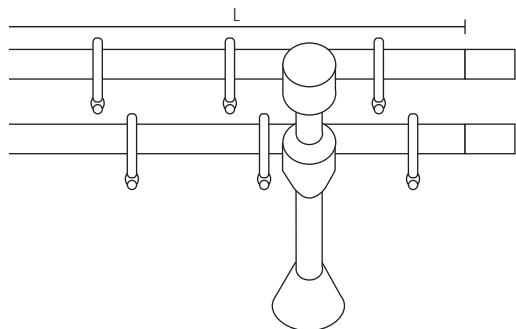

Scorritenda completo doppio a parete
 Complete double curtain set
 Tringle complète double
 Komplette doppelgarnitur
 Conjunto completo doble
 Karnisz podwójny kompletny montaż do ściany

FIN. = Finitura - Finish - Finition - Fertigung - Acabado - Wykonczenie
 An. = Anelli - Rings - Anneaux - Ringe - Anillas - Kółka
 Pin. = Pinze - Clips - Pincas - Clips - Pinzas - Żabki
 Gan. = Ganci - Hooks - Crochets - Rollenhaken - Ganchos - Haczyki
 Sup. = Supporti - Brackets - Supports - Träger - Soportes - Wsporniki

Cod. 124C51		Ø 12/12 mm						
FIN	cm	120	140	160	180	200	220	250
97								
98								
An. Cod. 524005	n.	12/12	14/14	16/16	18/18	20/20	22/22	26/26
Sup. cm 6 - 16	n.	2	2	2	2	3	3	3

Cod. 164C51		Ø 16/16 mm								
FIN	cm	120	140	160	180	200	220	250	300	340
97										
98										
An. Cod. 524006	n.	12/12	14/14	16/16	18/18	20/20	22/22	26/26	30/30	34/34
Sup. cm 6 - 16	n.	2	2	2	2	2	3	3	3	3

Cod. 204B51		Ø 20/20 mm								
FIN	cm	120	140	160	180	200	220	250	300	340
97										
98										
An. Cod. 524006	n.	12/12	14/14	16/16	18/18	20/20	22/22	26/26	30/30	34/34
Sup. cm 6 - 16	n.	2	2	2	2	2	3	3	3	3

Cod. 204N51		Ø 20/20 mm								
FIN	cm	120	140	160	180	200	220	250	300	340
97										
98										
Pin. Cod. 524014	n.	12/12	14/14	16/16	18/18	20/20	22/22	26/26	30/30	34/34
Sup. cm 6 - 16	n.	2	2	2	2	2	3	3	3	3

Cod. 204R51		Ø 20/20 mm								
FIN	cm	120	140	160	180	200	220	250	300	340
97										
98										
Gan. Cod. 524008	n.	12/12	14/14	16/16	18/18	20/20	22/22	26/26	30/30	34/34
Sup. cm 6 - 16	n.	2	2	2	2	2	3	3	3	3

Cod. 204S51		Ø 20/20 mm								
FIN	cm	120	140	160	180	200	220	250	300	340
97										
98										
Gan. Cod. 524009	n.	12/12	14/14	16/16	18/18	20/20	22/22	26/26	30/30	34/34
Sup. cm 6 - 16	n.	2	2	2	2	2	3	3	3	3

Cod. 204M51		Ø 20/20 mm								
FIN	cm	120	140	160	180	200	220	250	300	340
97										
98										
Pin / An.										
Cod. 524014 - 524006	n.	12/12	14/14	16/16	18/18	20/20	22/22	26/26	30/30	34/34
Sup. cm 6 - 16	n.	2	2	2	2	2	3	3	3	3

VENUS LANCIA

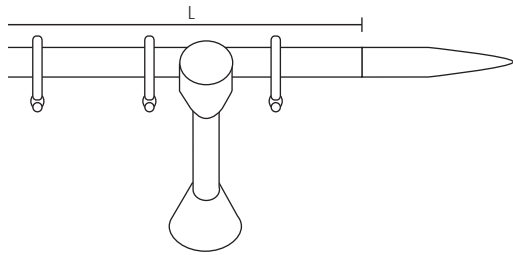

Scorritenda completo a parete
 Complete curtain set
 Tringle complète pose murale
 Komplette Wandgarnitur
 Conjunto completo a pared
 Karnisz kompletny montaż do ściany

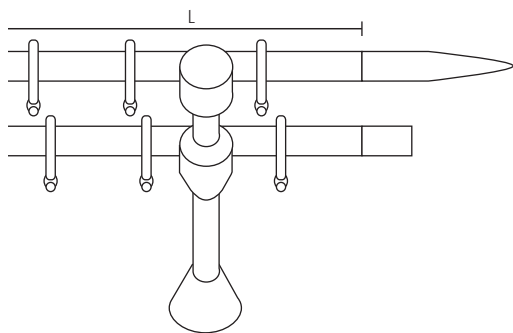

Scorritenda completo doppio a parete
 Complete double curtain set
 Tringle complète double
 Komplette doppelgarnitur
 Conjunto completo doble
 Karnisz podwójny kompletny montaż do ściany

FIN. = Finitura - Finish - Finition - Fertigung - Acabado - Wykonczenie
An. = Anelli - Rings - Anneaux - Ringe - Anillas - Kółka
Sup. = Supporti - Brackets - Supports - Träger - Soportes - Wsporniki

Cod. 124A53		Ø 12 mm						
FIN	cm	120	140	160	180	200	220	250
97								
98								
An.	n.	12	14	16	18	20	22	26
Sup. cm 6 - 16	n.	2	2	2	2	3	3	3

Cod. 164A53		Ø 16 mm								
FIN	cm	120	140	160	180	200	220	250	300	340
97										
98										
An.	n.	12	14	16	18	20	22	26	30	34
Sup. cm 6 - 16	n.	2	2	2	2	2	3	3	3	3

Cod. 124C53		Ø 12/12 mm						
FIN	cm	120	140	160	180	200	220	250
97								
98								
An.	n.	12/12	14/14	16/16	18/18	20/20	22/22	26/26
Sup. cm 6 - 16	n.	2	2	2	2	3	3	3

Cod. 164C53		Ø 16/16 mm								
FIN	cm	120	140	160	180	200	220	250	300	340
97										
98										
An.	n.	12/12	14/14	16/16	18/18	20/20	22/22	26/26	30/30	34/34
Sup. cm 6 - 16	n.	2	2	2	2	2	3	3	3	3

VENUS ANDROMEDA

Ø20



Fin. 97A

Acciaio satinato - Rosso
Satin stainless steel - Red
Acier satiné - Rouge

Stahl satiniert matt - Rot
Acero satinado - Rojo
Stal satynowy - Czerwony



Fin. 97B

Acciaio satinato - Verde
Satin stainless steel - Green
Acier satiné - Vert

Stahl satiniert matt - Grün
Acero satinado - Verde
Stal satynowy - Zielony



Fin. 97D

Acciaio satinato - Ambra
Satin stainless steel - Amber
Acier satiné - Ambre

Stahl satiniert matt - Bernstein
Acero satinado - Ambar
Stal satynowy - Bursztynowy

VENUS ANDROMEDA

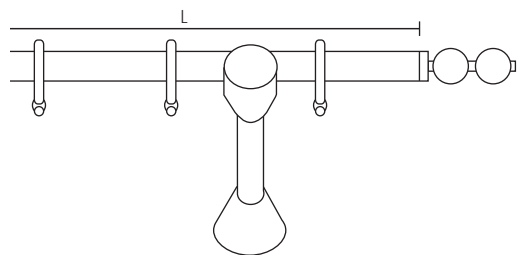

Scorritenda completo a parete
Complete curtain set
Tringle complète pose murale
Komplette Wandgarnitur
Conjunto completo a pared
Karnisz kompletny montaż do ściany

FIN. = Finitura - Finish - Finition - Fertigung - Acabado - Wykonczenie
An. = Anelli - Rings - Anneaux - Ringe - Anillas - Kółka
Pin. = Pinze - Clips - Pincas - Clips - Pinzas - Żabki
Sup. = Supporti - Brackets - Supports - Träger - Soportes - Wsporniki

Cod. 204A62 A/B/C/D		Ø 20 mm								
FIN	cm	120	140	160	180	200	220	250	300	340
97		292	304	316	328	340	409	431	458	482
An. Cod. 524006	n.	12	14	16	18	20	22	26	30	34
Sup. cm 6 - 16	n.	2	2	2	2	3	3	3	3	3

Cod. 204P62 A/B/C/D		Ø 20 mm								
FIN	cm	120	140	160	180	200	220	250	300	340
97		376	402	428	454	480	563	613	667	719
Pin. Cod. 524014	n.	12	14	16	18	20	22	26	30	34
Sup. cm 6 - 16	n.	2	2	2	2	2	3	3	3	3

Cod. 204E62 A/B/C/D		Ø 20 mm								
FIN	cm	120	140	160	180	200	220	250	300	340
97		269	277	285	293	302	391	405	424	441
Gan. Cod. 524008	n.	12	14	16	18	20	22	26	30	34
Sup. cm 6 - 16	n.	2	2	2	2	3	3*	3*	3*	3*

* Supporto intermedio Cod. 204119 - Central bracket Cod. 204119 - Supp. intermédiaire Cod. 204119
Mittelträger Cod. 204119 - Soporte intermedio Cod. 204119 - Wspornik środkowy Cod. 204119

Cod. 204H62 A/B/C/D		Ø 20 mm								
FIN	cm	120	140	160	180	200	220	250	300	340
97		316	332	348	364	380	478	508	543	575
Gan. Cod. 524009	n.	12	14	16	18	20	22	26	30	34
Sup. cm 6 - 16	n.	2	2	2	2	2	3*	3*	3*	3*

* Supporto intermedio Cod. 204119 - Central bracket Cod. 204119 - Supp. intermédiaire Cod. 204119
Mittelträger Cod. 204119 - Soporte intermedio Cod. 204119 - Wspornik środkowy Cod. 204119

Maggiorazione movimento a corda - Surcharge for corded systems - Supplément pour tirage
Zuschlag für Schnurbedienung - Suplemento por cuerda - Dodatkowo koszt mechanizmu

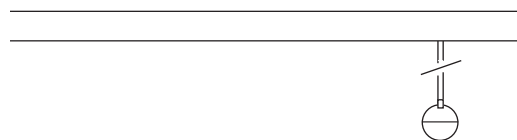

		Ø 20 mm								
	cm	120	140	160	180	200	220	250	300	340
		74	77	80	83	86	102	106	114	120



VENUS ANDROMEDA

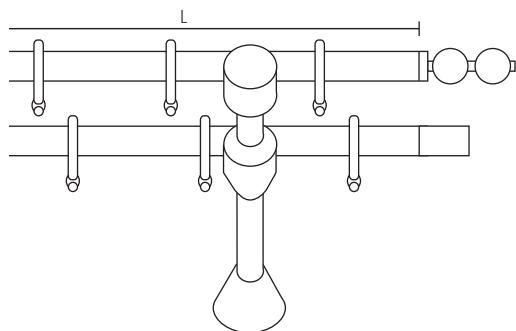

Scorritenda completo doppio a parete
 Complete double curtain set
 Tringle complète double
 Komplette doppelgarnitur
 Conjunto completo doble
 Karnisz podwójny kompletny montaż do ściany

FIN. = Finitura - Finish - Finition - Fertigung - Acabado - Wykonczenie
 An. = Anelli - Rings - Anneaux - Ringe - Anillas - Kółka
 Pin. = Pinze - Clips - Pincas - Clips - Pinzas - Żabki
 Sup. = Supporti - Brackets - Supports - Träger - Soportes - Wsporniki

Cod. 204B62 A/B/C/D		Ø 20/20 mm								
FIN	cm	120	140	160	180	200	220	250	300	340
97		464	488	513	537	561	672	715	769	817
An. Cod. 524006	n.	12/12	14/14	16/16	18/18	20/20	22/22	26/26	30/30	34/34
Sup. cm 6 - 16	n.	2	2	2	2	3	3	3	3	3

Cod. 204N62 A/B/C/D		Ø 20/20 mm								
FIN	cm	120	140	160	180	200	220	250	300	340
97		632	684	736	788	841	979	1.079	1.188	1.293
Pin. Cod. 524014	n.	12/12	14/14	16/16	18/18	20/20	22/22	26/26	30/30	34/34
Sup. cm 6 - 16	n.	2	2	2	2	2	3	3	3	3

Cod. 204R62 A/B/C/D		Ø 20/20 mm								
FIN	cm	120	140	160	180	200	220	250	300	340
97		418	434	451	467	484	587	615	653	686
Gan. Cod. 524008	n.	12/12	14/14	16/16	18/18	20/20	22/22	26/26	30/30	34/34
Sup. cm 6 - 16	n.	2	2	2	2	3	3	3	3	3

Cod. 204S62 A/B/C/D		Ø 20/20 mm								
FIN	cm	120	140	160	180	200	220	250	300	340
97		512	545	577	609	641	760	820	889	954
Gan. Cod. 524009	n.	12/12	14/14	16/16	18/18	20/20	22/22	26/26	30/30	34/34
Sup. cm 6 - 16	n.	2	2	2	2	3	3	3	3	3

Cod. 204M62 A/B/C/D		Ø 20/20 mm								
FIN	cm	120	140	160	180	200	220	250	300	340
97		548	586	624	663	701	826	897	978	1.055
Pin. / An.										
Cod. 524014 - 524006	n.	12/12	14/14	16/16	18/18	20/20	22/22	26/26	30/30	34/34
Sup. cm 6 - 16	n.	2	2	2	2	2	3	3	3	3



Components

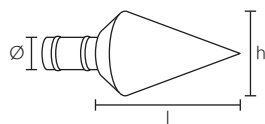

--4052

Terminale Cono
Finial Cono
Embout Cono

Endstück Cono
Terminal Cono
Końcówka Cono

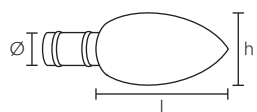

--4054

Terminale Ogiva
Finial Ogiva
Embout Ogiva

Endstück Ogiva
Terminal Ogiva
Końcówka Ogiva

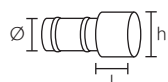

--4051

Terminale Cilindro
Finial Cilindro
Embout Cilindro

Endstück Cilindro
Terminal Cilindro
Końcówka Cilindro

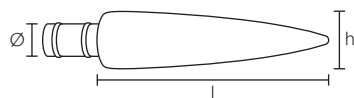

--4053

Terminale Lancia
Finial Lancia
Embout Lancia

Endstück Lancia
Terminal Lancia
Końcówka Lancia

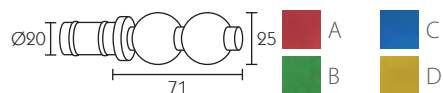

204062

Terminale Andromeda
Finial Andromeda
Embout Andromeda

Endstück Andromeda
Terminal Andromeda
Końcówka Andromeda

Cod.		124052	164052
FIN	Ø mm	12	16
	h - mm	25	28
	l - mm	36	50
97		14,40	19,90
98		15,20	20,60

Cod.		124054	164054	204054
FIN	Ø mm	12	16	20
	h - mm	18	25	25
	l - mm	32	43	43
97		14,40	19,90	20,00
98		15,20	20,60	22,10

Cod.		124051	164051	204051
FIN	Ø mm	12	16	20
	h - mm	12	16	20
	l - mm	10	17	20
97		14,40	19,90	20,00
98		15,20	20,60	22,10

Cod.		124053	164053	204063
FIN	Ø mm	12	16	20
	h - mm	12	15	29
	l - mm	55	70	70
97		14,40	19,90	20,00
98		15,20	20,60	22,10

Cod.		204062
FIN	Ø mm	20
97 A - B - C - D		
Murano		52,80



VENUS

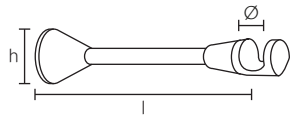

124319 1643--

Supporto
Bracket
Support

Träger
Soporte
Wspornik

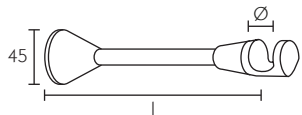

164339 2043--

Supporto con piastrina
Bracket with backplate
Support avec platine

Träger mit Plättchen
Soporte con plancha
Wspornik z podkładką

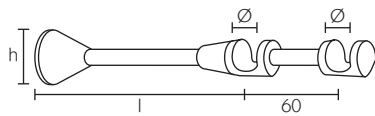

--4917 --4927

Supporto doppio
Double bracket
Support double

Doppelträger
Soporte doble
Wspornik podwójny

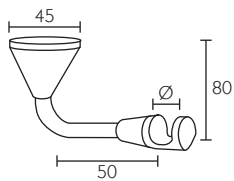

--4369

Supporto a soffitto
Ceiling bracket
Support à plafond

Deckenträger
Soporte a techo
Wspornik do sufitu

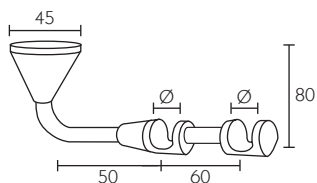

164367 204359

Supporto doppio a soffitto
Double ceiling bracket
Support à plafond double

Decken-Doppelträger
Soporte doble a techo
Wspornik podwójny do sufitu

Cod.		124319	164319	164329
FIN	Ø mm	12	16	16
	h - mm	35	40	40
	l - mm	160	160	240
97		44,90	47,90	49,90
98		46,60	49,70	51,60

Cod.		164339	204319	204329
FIN	Ø mm	16	20	20
	l - mm	160	160	240
97		53,80	56,70	58,70
98		55,80	62,40	64,50

Cod.		124917	164917	164927	204917	204927
FIN	Ø mm	12/12	16/16	16/16	20/20	20/20
	h - mm	35	45	45	45	45
	l - mm	160	160	240	160	240
97		68,70	73,20	75,20	86,50	89,20
98		74,80	79,40	81,30	95,20	98,10

Cod.		164369	204349
FIN	Ø mm	16	20
97		57,40	60,30
98		59,40	66,40

Cod.		164367	204359
FIN	Ø mm	16/16	20/20
97		75,50	88,80
98		83,00	97,60



Components

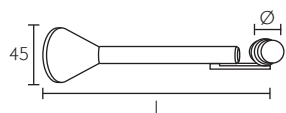

1641-- 2041--

Supporto intermedio
Central bracket
Support intermédiaire

Mittelträger
Soporte intermedio
Wspornik środkowy

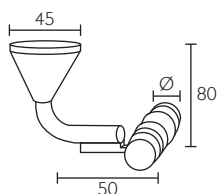

164379 204339

Supporto intermedio a soffitto
Central ceiling bracket
Support intermédiaire à plafond
Deckenmittelträger
Soporte intermedio a techo
Wspornik środkowy do sufitu

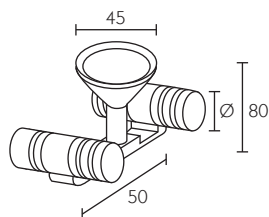

164377 204367

Supporto doppio intermedio a soffitto
Central double ceiling bracket
Support double intermédiaire à plafond
Decken-Mitteldoppelträger
Soporte doble intermedio a techo
Wspornik podwójny środkowy do sufitu

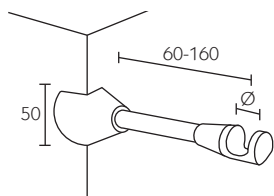

--4399

Supporto angolare esterno
External angle bracket
Support pour angle externe
Außenwinkel Träger
Soporte angulo externo
Wspornik kątowy zewnętrzny

Cod.		164149	164159	204119	204169
FIN	Ø mm	16	16	20	20
	l - mm	60 - 160	60 - 240	60 - 160	60 - 240
97		80,00	81,50	80,00	81,50
98		81,90	83,40	81,90	83,40

Cod.		164379	204339
FIN	Ø mm	16	20
97		81,50	81,50
98		89,70	89,70

Cod.		164377	204367
FIN	Ø mm	16/16	20/20
97		104,70	104,70
98		115,20	115,20

Cod.		164399	204399
FIN	Ø mm	16	20
97		87,20	87,20
98		96,40	96,40



VENUS

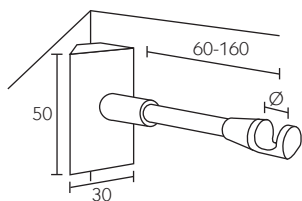

164139 204129

Supporto angolare interno
Internal angle bracket
Support pour angle interne
Innenwinkel Träger
Soporte ángulo interno
Wspornik kątowy wewnętrzny

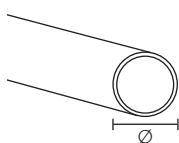

--4100

Tubo
Tube
Tube
Rohr
Tubo
Rura

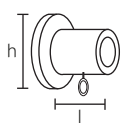

--4001

Rosetta a muro
Recess bracket
Naissance murale
Wandlager
Soporte lateral
Podkładka do muru

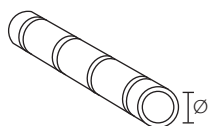

5640--

Giunzione
Junction
Jonction

Verbinder
Enchufe
Łącznik

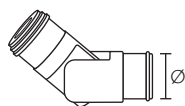

--4005

Angolare articolato
Angle joint
Angle articulé

Gelenkstück
Ángulo articulado
Kątownik ruchomy

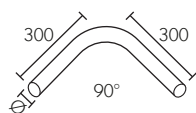

--4002

Curva
Curve
Courbe

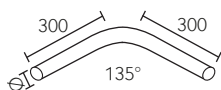

--4003

Kurve
Curva
Kolanko

Cod.		164139	204129
FIN	Ø mm	16	20
97		94,50	94,50
98		103,90	103,90

Cod.		124100	164100	204100	124001	164001	204001
FIN	Ø mm	12	16	20	12	16	20
	h - mm				20	26	30
	l - mm				22	28	32
97		19,90	22,00	24,00	25,10	26,30	30,10
98		24,40	27,50	28,80	26,00	27,50	36,10

Cod.		564020	564021	564019
FIN	Ø mm	12	16	20
97		11,70	12,60	2,50

Cod.		124005	164005	204005
FIN	Ø mm	12	16	20
97		42,00	48,10	55,00
98		43,50	49,60	66,00

Cod.		164002	204002	164003	204003
FIN	Ø mm	16	20	16	20
97		40,40	42,40	40,40	42,40
98		67,30	69,30	67,30	69,30



110

Components

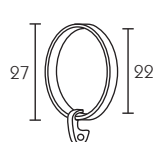

524005
Anello
Ring
Anneau

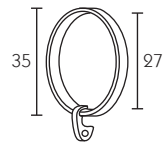

524006
Ring
Anilla
Kólko



524008
Gancio
Hook
Crochet
Haken
Gancho
Haczyk



524009
Gancio con sfere
Sphere hook
Crochet à roulettes
Röllenhaken
Gancho con esferas
Haczyk z kulkami

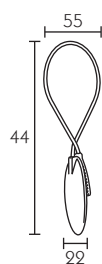

524014
Pinza
Clip
Pince

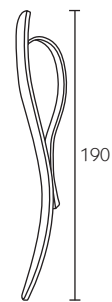

524037
Clip
Pinza
Žabka

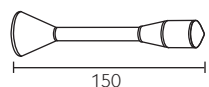

514002
Fermatenda
Holdback
Porte-embrasse

Raffhalter
Alzapaño
Przytrzymanie franki

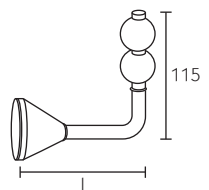

504011
Fermatenda **Andromeda**
Holdback **Andromeda**
Porte-embrasse **Andromeda**
Raffhalter **Andromeda**
Alzapaño **Andromeda**
Przytrzymanie franki **Andromeda**



Cod.		524005	524006
FIN	Ø mm	12	16 / 20
97		3,28	3,66
98		3,28	3,66

Cod.		524008	524009
FIN	Ø mm	20	20
97		1,73	5,67

Cod.		524014	524037
FIN	Ø mm		
97		10,65	18,67
98		10,65	20,90

Cod.		514002
FIN		
97		38,80
98		43,30

Cod.		504011	504012	504013
FIN	l - mm	100	150	200
97 A - B - C - D				
Murano		63,80	67,50	71,20

