

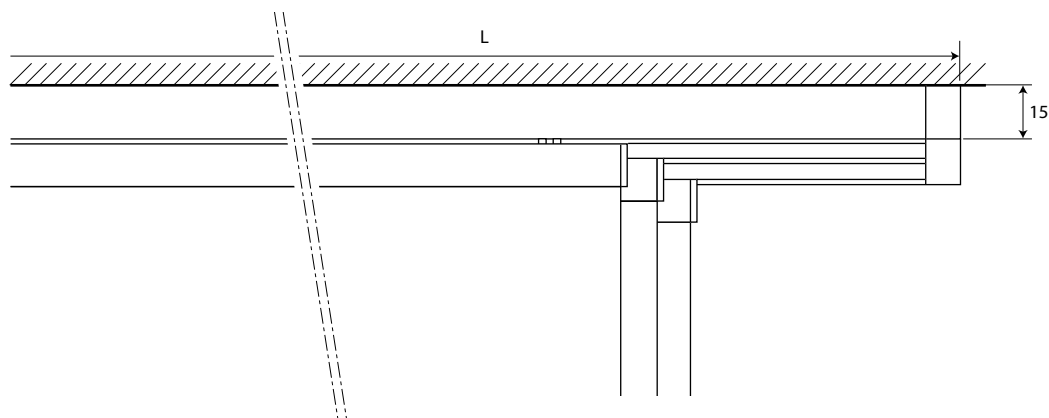



# MOIRA



## Cod. 373T99

Sistema a soffitto - 3 vie  
 Ceiling system - 3 ways  
 Système plafond - 3 voies  
 Deckenmontage - 3läufig  
 Sistema techo - 3 vías  
 System sufitowy - 3 biegi

## Cod. 473T99

Sistema a soffitto - 4 vie  
 Ceiling system - 4 ways  
 Système plafond - 4 voies  
 Deckenmontage - 4läufig  
 Sistema techo - 4 vías  
 System sufitowy - 4 biegi

## Cod. 573T99

Sistema a soffitto - 5 vie  
 Ceiling system - 5 ways  
 Système plafond - 5 voies  
 Deckenmontage - 5läufig  
 Sistema techo - 5 vías  
 System sufitowy - 5 biegi

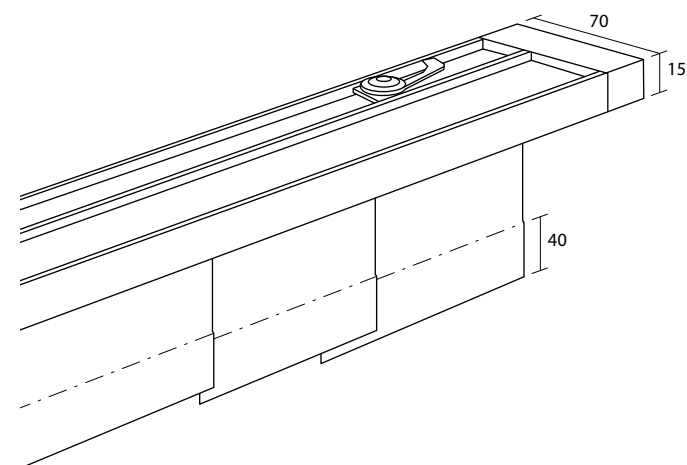

25



65



67



81



87

FIN 81 - 87\*\* \*\*

3 vie - 3 ways - 3 voies - 3läufig - 3 vías - 3 biegi

| L - cm         | 180       |   |   |   |   |   | 200       |   |   |   |   |   | 220       |   |   |   |   |   |
|----------------|-----------|---|---|---|---|---|-----------|---|---|---|---|---|-----------|---|---|---|---|---|
| CT             | A         | B | C | D | E | F | A         | B | C | D | E | F | A         | B | C | D | E | F |
| 160            |           |   |   |   |   |   |           |   |   |   |   |   |           |   |   |   |   |   |
| 180            |           |   |   |   |   |   |           |   |   |   |   |   |           |   |   |   |   |   |
| 200            |           |   |   |   |   |   |           |   |   |   |   |   |           |   |   |   |   |   |
| 220            |           |   |   |   |   |   |           |   |   |   |   |   |           |   |   |   |   |   |
| 240            |           |   |   |   |   |   |           |   |   |   |   |   |           |   |   |   |   |   |
| 260            |           |   |   |   |   |   |           |   |   |   |   |   |           |   |   |   |   |   |
| 280            |           |   |   |   |   |   |           |   |   |   |   |   |           |   |   |   |   |   |
| 300            |           |   |   |   |   |   |           |   |   |   |   |   |           |   |   |   |   |   |
| 320            |           |   |   |   |   |   |           |   |   |   |   |   |           |   |   |   |   |   |
| <b>LP - cm</b> | <b>66</b> |   |   |   |   |   | <b>72</b> |   |   |   |   |   | <b>78</b> |   |   |   |   |   |

| L - cm         | 240       |   |   |   |   |   | 260       |   |   |   |   |   | 280        |   |   |   |   |   |
|----------------|-----------|---|---|---|---|---|-----------|---|---|---|---|---|------------|---|---|---|---|---|
| CT             | A         | B | C | D | E | F | A         | B | C | D | E | F | A          | B | C | D | E | F |
| 160            |           |   |   |   |   |   |           |   |   |   |   |   |            |   |   |   |   |   |
| 180            |           |   |   |   |   |   |           |   |   |   |   |   |            |   |   |   |   |   |
| 200            |           |   |   |   |   |   |           |   |   |   |   |   |            |   |   |   |   |   |
| 220            |           |   |   |   |   |   |           |   |   |   |   |   |            |   |   |   |   |   |
| 240            |           |   |   |   |   |   |           |   |   |   |   |   |            |   |   |   |   |   |
| 260            |           |   |   |   |   |   |           |   |   |   |   |   |            |   |   |   |   |   |
| 280            |           |   |   |   |   |   |           |   |   |   |   |   |            |   |   |   |   |   |
| 300            |           |   |   |   |   |   |           |   |   |   |   |   |            |   |   |   |   |   |
| 320            |           |   |   |   |   |   |           |   |   |   |   |   |            |   |   |   |   |   |
| <b>LP - cm</b> | <b>86</b> |   |   |   |   |   | <b>92</b> |   |   |   |   |   | <b>100</b> |   |   |   |   |   |

| L - cm         | 300        |   |   |   |   |   | 320        |   |   |   |   |   | 340        |   |   |   |   |   |
|----------------|------------|---|---|---|---|---|------------|---|---|---|---|---|------------|---|---|---|---|---|
| CT             | A          | B | C | D | E | F | A          | B | C | D | E | F | A          | B | C | D | E | F |
| 160            |            |   |   |   |   |   |            |   |   |   |   |   |            |   |   |   |   |   |
| 180            |            |   |   |   |   |   |            |   |   |   |   |   |            |   |   |   |   |   |
| 200            |            |   |   |   |   |   |            |   |   |   |   |   |            |   |   |   |   |   |
| 220            |            |   |   |   |   |   |            |   |   |   |   |   |            |   |   |   |   |   |
| 240            |            |   |   |   |   |   |            |   |   |   |   |   |            |   |   |   |   |   |
| 260            |            |   |   |   |   |   |            |   |   |   |   |   |            |   |   |   |   |   |
| 280            |            |   |   |   |   |   |            |   |   |   |   |   |            |   |   |   |   |   |
| 300            |            |   |   |   |   |   |            |   |   |   |   |   |            |   |   |   |   |   |
| 320            |            |   |   |   |   |   |            |   |   |   |   |   |            |   |   |   |   |   |
| <b>LP - cm</b> | <b>106</b> |   |   |   |   |   | <b>112</b> |   |   |   |   |   | <b>120</b> |   |   |   |   |   |

\* I prezzi dei sistemi completi sono riferiti a tessuti nella stessa variante colore. Non è compreso l'allineamento dell'eventuale disegno del tessuto.

The prices of the complete systems are referred to fabrics in the same colour variant. The alignment of any drawing of the fabric is not included.

Les prix des systèmes complets se réfèrent aux tissus dans la même variante de coloris. L'éventuel alignement du dessin de la toile n'est pas inclus.

Die Preise der Komplettsysteme beziehen sich auf die Stoffe in der gleichen Farbvariante. Eine eventuelle Anpassung des Stoffdesigns ist nicht enthalten.

Los precios de los sistemas completos se refieren a telas en la misma variante de color. La alineación del dibujo del tejido no está incluida.

Ceny kompletnych systemów odnoszą się do tkanin w tym samym wariantcie kolorystycznym. Cena nie uwzględnia ewentualnego wyrównania wzorów tkanin.

\*\* Terminali in ABS e peso interno 40x4mm - Finales in ABS and internal weight 40x4mm - Embouts en ABS et lestage interne 40x4mm

Endkappe aus ABS und Innenbeschwerung 40x4mm - Tapones en ABS y contrapeso interior 40x4mm - Zatyczka ABS i obciążnik wewnętrzny 40x4mm

## Maggiorazioni - Surcharges - Suppléments - Zuschläge - Suplementos - Dodatkowa opłata

| L - cm          | 180 | 200 | 220 | 240 | 260 | 280 | 300 | 320 | 340 |
|-----------------|-----|-----|-----|-----|-----|-----|-----|-----|-----|
| 25 - 65 - 67**  |     |     |     |     |     |     |     |     |     |
| 25 - 65 - 67*** |     |     |     |     |     |     |     |     |     |
| 81 - 87***      |     |     |     |     |     |     |     |     |     |

\*\*\* Terminali e peso esterno da 25mm in alluminio - Finales and external weight 25mm in aluminium - Embouts et lestage 25mm en aluminium

Endkappe und Aussenbeschwerung 25mm aus Aluminium - Tapones y contrapeso exterior 25mm en aluminio - Zatyczka i obciążnik zewnętrzny 25 mm z aluminium

## Movimento a corda - Corded systems - Tirage - Schnurbedienung - Movimiento de cuerda - Koszt mechanizmu

| L - cm       | 180 | 200 | 220 | 240 | 260 | 280 | 300 | 320 | 340 |
|--------------|-----|-----|-----|-----|-----|-----|-----|-----|-----|
| 25 - 65 - 67 |     |     |     |     |     |     |     |     |     |
| 81 - 87      |     |     |     |     |     |     |     |     |     |

FIN = Finitura - Finish - Finition - Fertigung - Acabado - Wykończenie

L = Larghezza sistema (cm) - System width (cm) - Largeur système (cm) - Gesamtbreite (cm) - Ancho sistema (cm) - Szerokość systemu (cm)

CT = Classe tessuto - Fabric category - Catégorie tissu - Gewebegruppe - Categoría tejido - Klasa tkaniny

C = Altezza tessuto (cm) - Fabric height (cm) - Hauteur de la toile (cm) - Stoff Höhe (cm) - Altura tejido (cm) - Wysokość tkaniny (cm)

LP = Larghezza pannello (cm) - Panel width (cm) - Largeur panneau (cm) - Paneelebreite (cm) - Ancho panel (cm) - Szerokość panelu (cm)

FIN 81 - 87\* \*\*

4 vie - 4 ways - 4 voies - 4läufig - 4 vías - 4 biegi

| L - cm         | CT     | 260       |   |   |   |   |   | 280       |   |   |   |   |   | 300       |   |   |   |   |   |  |
|----------------|--------|-----------|---|---|---|---|---|-----------|---|---|---|---|---|-----------|---|---|---|---|---|--|
|                |        | A         | B | C | D | E | F | A         | B | C | D | E | F | A         | B | C | D | E | F |  |
| 160            | C - cm |           |   |   |   |   |   |           |   |   |   |   |   |           |   |   |   |   |   |  |
| 180            |        |           |   |   |   |   |   |           |   |   |   |   |   |           |   |   |   |   |   |  |
| 200            |        |           |   |   |   |   |   |           |   |   |   |   |   |           |   |   |   |   |   |  |
| 220            |        |           |   |   |   |   |   |           |   |   |   |   |   |           |   |   |   |   |   |  |
| 240            |        |           |   |   |   |   |   |           |   |   |   |   |   |           |   |   |   |   |   |  |
| 260            |        |           |   |   |   |   |   |           |   |   |   |   |   |           |   |   |   |   |   |  |
| 280            |        |           |   |   |   |   |   |           |   |   |   |   |   |           |   |   |   |   |   |  |
| 300            |        |           |   |   |   |   |   |           |   |   |   |   |   |           |   |   |   |   |   |  |
| 320            |        |           |   |   |   |   |   |           |   |   |   |   |   |           |   |   |   |   |   |  |
| <b>LP - cm</b> |        | <b>70</b> |   |   |   |   |   | <b>76</b> |   |   |   |   |   | <b>80</b> |   |   |   |   |   |  |

| L - cm         | CT     | 320       |   |   |   |   |   | 340       |   |   |   |   |   | 360       |   |   |   |   |   |  |
|----------------|--------|-----------|---|---|---|---|---|-----------|---|---|---|---|---|-----------|---|---|---|---|---|--|
|                |        | A         | B | C | D | E | F | A         | B | C | D | E | F | A         | B | C | D | E | F |  |
| 160            | C - cm |           |   |   |   |   |   |           |   |   |   |   |   |           |   |   |   |   |   |  |
| 180            |        |           |   |   |   |   |   |           |   |   |   |   |   |           |   |   |   |   |   |  |
| 200            |        |           |   |   |   |   |   |           |   |   |   |   |   |           |   |   |   |   |   |  |
| 220            |        |           |   |   |   |   |   |           |   |   |   |   |   |           |   |   |   |   |   |  |
| 240            |        |           |   |   |   |   |   |           |   |   |   |   |   |           |   |   |   |   |   |  |
| 260            |        |           |   |   |   |   |   |           |   |   |   |   |   |           |   |   |   |   |   |  |
| 280            |        |           |   |   |   |   |   |           |   |   |   |   |   |           |   |   |   |   |   |  |
| 300            |        |           |   |   |   |   |   |           |   |   |   |   |   |           |   |   |   |   |   |  |
| 320            |        |           |   |   |   |   |   |           |   |   |   |   |   |           |   |   |   |   |   |  |
| <b>LP - cm</b> |        | <b>86</b> |   |   |   |   |   | <b>90</b> |   |   |   |   |   | <b>96</b> |   |   |   |   |   |  |

| L - cm         | CT     | 380       |   |   |   |   |   | 400        |   |   |   |   |   | 420        |   |   |   |   |   |  |
|----------------|--------|-----------|---|---|---|---|---|------------|---|---|---|---|---|------------|---|---|---|---|---|--|
|                |        | A         | B | C | D | E | F | A          | B | C | D | E | F | A          | B | C | D | E | F |  |
| 160            | C - cm |           |   |   |   |   |   |            |   |   |   |   |   |            |   |   |   |   |   |  |
| 180            |        |           |   |   |   |   |   |            |   |   |   |   |   |            |   |   |   |   |   |  |
| 200            |        |           |   |   |   |   |   |            |   |   |   |   |   |            |   |   |   |   |   |  |
| 220            |        |           |   |   |   |   |   |            |   |   |   |   |   |            |   |   |   |   |   |  |
| 240            |        |           |   |   |   |   |   |            |   |   |   |   |   |            |   |   |   |   |   |  |
| 260            |        |           |   |   |   |   |   |            |   |   |   |   |   |            |   |   |   |   |   |  |
| 280            |        |           |   |   |   |   |   |            |   |   |   |   |   |            |   |   |   |   |   |  |
| 300            |        |           |   |   |   |   |   |            |   |   |   |   |   |            |   |   |   |   |   |  |
| 320            |        |           |   |   |   |   |   |            |   |   |   |   |   |            |   |   |   |   |   |  |
| <b>LP - cm</b> |        | <b>96</b> |   |   |   |   |   | <b>106</b> |   |   |   |   |   | <b>110</b> |   |   |   |   |   |  |

\* I prezzi dei sistemi completi sono riferiti a tessuti nella stessa variante colore. Non è compreso l'allineamento dell'eventuale disegno del tessuto.  
 The prices of the complete systems are referred to fabrics in the same colour variant. The alignment of any drawing of the fabric is not included.  
 Les prix des systèmes complets se réfèrent aux tissus dans la même variante de coloris. L'éventuel alignement du dessin de la toile n'est pas inclus.  
 Die Preise der Komplettsysteme beziehen sich auf die Stoffe in der gleichen Farbvariante. Eine eventuelle Anpassung des Stoffdesigns ist nicht enthalten.  
 Los precios de los sistemas completos se refieren a telas en la misma variante de color. La alineación del dibujo del tejido no está incluida.  
 Ceny kompletnych systemów odnoszą się do tkanin w tym samym wariacie kolorystycznym. Cena nie uwzględnia ewentualnego wyrównania wzorów tkanin.

\*\* Terminali in ABS e peso interno 40x4mm - Finials in ABS and internal weight 40x4mm - Embouts en ABS et lestage interne 40x4mm  
 Endkappe aus ABS und Innenbeschwerung 40x4mm - Tapones en ABS y contrapeso interior 40x4mm - Zatyczka ABS i obciążnik wewnętrzny 40x4mm

## Maggiorazioni - Surcharges - Suppléments - Zuschläge - Suplementos - Dodatkowa opłata

| L - cm          | 260 | 280 | 300 | 320 | 340 | 360 | 380 | 400 | 420 |
|-----------------|-----|-----|-----|-----|-----|-----|-----|-----|-----|
| 25 - 65 - 67**  |     |     |     |     |     |     |     |     |     |
| 25 - 65 - 67*** |     |     |     |     |     |     |     |     |     |
| 81 - 87***      |     |     |     |     |     |     |     |     |     |

\*\*\* Terminali e peso esterno da 25mm in alluminio - Finials and external weight 25mm in aluminium - Embouts et lestage 25mm en aluminium  
 Endkappe und Aussenbeschwerung 25mm aus Aluminium - Tapones y contrapeso exterior 25mm en aluminio - Zatyczka i obciążnik zewnętrzny 25 mm z aluminium

## Movimento a corda - Corded systems - Tirage - Schnurbedienung - Movimiento de cuerda - Koszt mechanizmu

| L - cm       | 260 | 280 | 300 | 320 | 340 | 360 | 380 | 400 | 420 |
|--------------|-----|-----|-----|-----|-----|-----|-----|-----|-----|
| 25 - 65 - 67 |     |     |     |     |     |     |     |     |     |
| 81 - 87      |     |     |     |     |     |     |     |     |     |

FIN = Finitura - Finish - Finition - Fertigung - Acabado - Wykończenie  
 L = Larghezza sistema (cm) - System width (cm) - Largeur système (cm) - Gesamtbreite (cm) - Ancho sistema (cm) - Szerokość systemu (cm)  
 CT = Classe tessuto - Fabric category - Catégorie tissu - Gewebegruppe - Categoría tejido - Klasa tkaniny  
 C = Altezza tessuto (cm) - Fabric height (cm) - Hauteur de la toile (cm) - Stoff Höhe (cm) - Altura tejido (cm) - Wysokość tkaniny (cm)  
 LP = Larghezza pannello (cm) - Panel width (cm) - Largeur panneau (cm) - Paneelebreite (cm) - Ancho panel (cm) - Szerokość panelu (cm)

| L - cm         | 340       |   |   |   |   |   | 360       |   |   |   |   |   | 380       |   |   |   |   |   |
|----------------|-----------|---|---|---|---|---|-----------|---|---|---|---|---|-----------|---|---|---|---|---|
| CT             | A         | B | C | D | E | F | A         | B | C | D | E | F | A         | B | C | D | E | F |
| 160            |           |   |   |   |   |   |           |   |   |   |   |   |           |   |   |   |   |   |
| 180            |           |   |   |   |   |   |           |   |   |   |   |   |           |   |   |   |   |   |
| 200            |           |   |   |   |   |   |           |   |   |   |   |   |           |   |   |   |   |   |
| 220            |           |   |   |   |   |   |           |   |   |   |   |   |           |   |   |   |   |   |
| 240            |           |   |   |   |   |   |           |   |   |   |   |   |           |   |   |   |   |   |
| 260            |           |   |   |   |   |   |           |   |   |   |   |   |           |   |   |   |   |   |
| 280            |           |   |   |   |   |   |           |   |   |   |   |   |           |   |   |   |   |   |
| 300            |           |   |   |   |   |   |           |   |   |   |   |   |           |   |   |   |   |   |
| 320            |           |   |   |   |   |   |           |   |   |   |   |   |           |   |   |   |   |   |
| <b>LP - cm</b> | <b>74</b> |   |   |   |   |   | <b>78</b> |   |   |   |   |   | <b>82</b> |   |   |   |   |   |

| L - cm         | 400       |   |   |   |   |   | 440       |   |   |   |   |   | 460       |   |   |   |   |   |
|----------------|-----------|---|---|---|---|---|-----------|---|---|---|---|---|-----------|---|---|---|---|---|
| CT             | A         | B | C | D | E | F | A         | B | C | D | E | F | A         | B | C | D | E | F |
| 160            |           |   |   |   |   |   |           |   |   |   |   |   |           |   |   |   |   |   |
| 180            |           |   |   |   |   |   |           |   |   |   |   |   |           |   |   |   |   |   |
| 200            |           |   |   |   |   |   |           |   |   |   |   |   |           |   |   |   |   |   |
| 220            |           |   |   |   |   |   |           |   |   |   |   |   |           |   |   |   |   |   |
| 240            |           |   |   |   |   |   |           |   |   |   |   |   |           |   |   |   |   |   |
| 260            |           |   |   |   |   |   |           |   |   |   |   |   |           |   |   |   |   |   |
| 280            |           |   |   |   |   |   |           |   |   |   |   |   |           |   |   |   |   |   |
| 300            |           |   |   |   |   |   |           |   |   |   |   |   |           |   |   |   |   |   |
| 320            |           |   |   |   |   |   |           |   |   |   |   |   |           |   |   |   |   |   |
| <b>LP - cm</b> | <b>86</b> |   |   |   |   |   | <b>92</b> |   |   |   |   |   | <b>94</b> |   |   |   |   |   |

| L - cm         | 460       |   |   |   |   |   | 480        |   |   |   |   |   | 500        |   |   |   |   |   |
|----------------|-----------|---|---|---|---|---|------------|---|---|---|---|---|------------|---|---|---|---|---|
| CT             | A         | B | C | D | E | F | A          | B | C | D | E | F | A          | B | C | D | E | F |
| 160            |           |   |   |   |   |   |            |   |   |   |   |   |            |   |   |   |   |   |
| 180            |           |   |   |   |   |   |            |   |   |   |   |   |            |   |   |   |   |   |
| 200            |           |   |   |   |   |   |            |   |   |   |   |   |            |   |   |   |   |   |
| 220            |           |   |   |   |   |   |            |   |   |   |   |   |            |   |   |   |   |   |
| 240            |           |   |   |   |   |   |            |   |   |   |   |   |            |   |   |   |   |   |
| 260            |           |   |   |   |   |   |            |   |   |   |   |   |            |   |   |   |   |   |
| 280            |           |   |   |   |   |   |            |   |   |   |   |   |            |   |   |   |   |   |
| 300            |           |   |   |   |   |   |            |   |   |   |   |   |            |   |   |   |   |   |
| 320            |           |   |   |   |   |   |            |   |   |   |   |   |            |   |   |   |   |   |
| <b>LP - cm</b> | <b>98</b> |   |   |   |   |   | <b>102</b> |   |   |   |   |   | <b>106</b> |   |   |   |   |   |

\* I prezzi dei sistemi completi sono riferiti a tessuti nella stessa variante colore. Non è compreso l'allineamento dell'eventuale disegno del tessuto.  
 The prices of the complete systems are referred to fabrics in the same colour variant. The alignment of any drawing of the fabric is not included.  
 Les prix des systèmes complets se réfèrent aux tissus dans la même variante de coloris. L'éventuel alignement du dessin de la toile n'est pas inclus.  
 Die Preise der Komplettsysteme beziehen sich auf die Stoffe in der gleichen Farbvariante. Eine eventuelle Anpassung des Stoffdesigns ist nicht enthalten.  
 Los precios de los sistemas completos se refieren a telas en la misma variante de color. La alineación del dibujo del tejido no está incluida.  
 Ceny kompletnych systemów odnoszą się do tkanin w tym samym wariacie kolorystycznym. Cena nie uwzględnia ewentualnego wyrównania wzorów tkanin.  
 \*\* Terminali in ABS e peso interno 40x4mm - Finales in ABS and internal weight 40x4mm - Embouts en ABS et lestage interne 40x4mm  
 Endkappe aus ABS und Innenbeschwerung 40x4mm - Tapones en ABS y contrapeso interior 40x4mm - Zatyczka ABS i obciążnik wewnętrzny 40x4mm

## Maggiorazioni - Surcharges - Suppléments - Zuschläge - Suplementos - Dodatkowa opłata

| L - cm          | 340 | 360 | 380 | 400 | 420 | 440 | 460 | 480 | 500 |
|-----------------|-----|-----|-----|-----|-----|-----|-----|-----|-----|
| 25 - 65 - 67**  |     |     |     |     |     |     |     |     |     |
| 25 - 65 - 67*** |     |     |     |     |     |     |     |     |     |
| 81 - 87***      |     |     |     |     |     |     |     |     |     |

\*\*\* Terminali e peso esterno da 25mm in alluminio - Finales and external weight 25mm in aluminium - Embouts et lestage 25mm en aluminium  
 Endkappe und Aussenbeschwerung 25mm aus Aluminium - Tapones y contrapeso exterior 25mm en aluminio - Zatyczka i obciążnik zewnętrzny 25 mm z aluminium

## Movimento a corda - Corded systems - Tirage - Schnurbedienung - Movimiento de cuerda - Koszt mechanizmu

| L - cm       | 340 | 360 | 380 | 400 | 420 | 440 | 460 | 480 | 500 |
|--------------|-----|-----|-----|-----|-----|-----|-----|-----|-----|
| 25 - 65 - 67 |     |     |     |     |     |     |     |     |     |
| 81 - 87      |     |     |     |     |     |     |     |     |     |

FIN = Finitura - Finish - Finition - Fertigung - Acabado - Wykończenie  
 L = Larghezza sistema (cm) - System width (cm) - Largeur système (cm) - Gesamtbreite (cm) - Ancho sistema (cm) - Szerokość systemu (cm)  
 CT = Classe tessuto - Fabric category - Catégorie tissu - Gewebegruppe - Categoría tejido - Klasa tkaniny  
 C = Altezza tessuto (cm) - Fabric height (cm) - Hauteur de la toile (cm) - Stoff Höhe (cm) - Altura tejido (cm) - Wysokość tkaniny (cm)  
 LP = Larghezza pannello (cm) - Panel width (cm) - Largeur panneau (cm) - Paneelebreite (cm) - Ancho panel (cm) - Szerokość panelu (cm)

# MOIRA

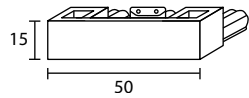

373045

Tappo strappo  
Simple endcap  
Bouchon simple  
Endkappe  
Tapón simple  
Zatyczka

373055

Tappo ritorno corda  
Endcap return pulley  
Bouchon contrepoulie  
Rückschnurkappe  
Tapón contrapolea  
Zatyczka do sznurka

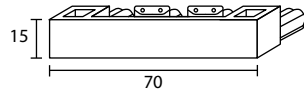

473045

Tappo strappo  
Simple endcap  
Bouchon simple  
Endkappe  
Tapón simple  
Zatyczka

473055

Tappo ritorno corda  
Endcap return pulley  
Bouchon contrepoulie  
Rückschnurkappe  
Tapón contrapolea  
Zatyczka do sznurka

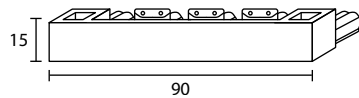

573045

Tappo strappo  
Simple endcap  
Bouchon simple  
Endkappe  
Tapón simple  
Zatyczka

573055

Tappo ritorno corda  
Endcap return pulley  
Bouchon contrepoulie  
Rückschnurkappe  
Tapón contrapolea  
Zatyczka do sznurka

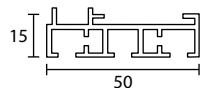

373300

Binario  
Track  
Rail

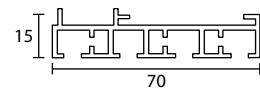

473400

Schiene  
Riel  
Tor

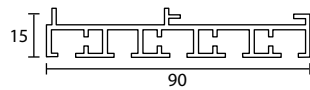

573500

Binario  
Track  
Rail

Schiene  
Riel  
Tor

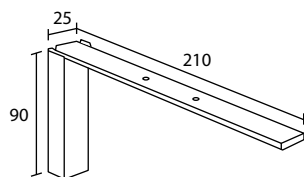

443309

Supporto con cover  
Bracket with cover  
Support avec couverture

Träger mit Deckel  
Soporte con cover  
Wspornik z nakładką

Vie = Ways - Voies - Schiene - Vías - Biegi

|                |            |               |               |
|----------------|------------|---------------|---------------|
| <b>Cod.</b>    |            | <b>373045</b> | <b>373055</b> |
| <b>FIN</b>     | <b>Vie</b> | <b>3</b>      | <b>3</b>      |
| <b>25</b>      |            |               |               |
| <b>65 - 67</b> |            |               |               |
| <b>81 - 87</b> | <b>ABS</b> |               |               |

|                |            |               |               |
|----------------|------------|---------------|---------------|
| <b>Cod.</b>    |            | <b>473045</b> | <b>473055</b> |
| <b>FIN</b>     | <b>Vie</b> | <b>4</b>      | <b>4</b>      |
| <b>25</b>      |            |               |               |
| <b>65 - 67</b> |            |               |               |
| <b>81 - 87</b> | <b>ABS</b> |               |               |

|                |            |               |               |
|----------------|------------|---------------|---------------|
| <b>Cod.</b>    |            | <b>573045</b> | <b>573055</b> |
| <b>FIN</b>     | <b>Vie</b> | <b>5</b>      | <b>5</b>      |
| <b>25</b>      |            |               |               |
| <b>65 - 67</b> |            |               |               |
| <b>81 - 87</b> | <b>ABS</b> |               |               |

|                |            |               |               |
|----------------|------------|---------------|---------------|
| <b>Cod.</b>    |            | <b>373300</b> | <b>473400</b> |
| <b>FIN</b>     | <b>Vie</b> | <b>3</b>      | <b>4</b>      |
| <b>25</b>      |            |               |               |
| <b>65 - 67</b> |            |               |               |
| <b>81 - 87</b> |            |               |               |

|                |            |               |
|----------------|------------|---------------|
| <b>Cod.</b>    |            | <b>573500</b> |
| <b>FIN</b>     | <b>Vie</b> | <b>5</b>      |
| <b>25</b>      |            |               |
| <b>65 - 67</b> |            |               |
| <b>81 - 87</b> | <b>ABS</b> |               |

|                |  |               |
|----------------|--|---------------|
| <b>Cod.</b>    |  | <b>443309</b> |
| <b>FIN</b>     |  |               |
| <b>25</b>      |  |               |
| <b>65 - 67</b> |  |               |
| <b>81 - 87</b> |  |               |

# MOIRA

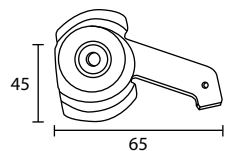

373998  
Supporto  
Bracket  
Support

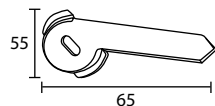

573998  
Träger  
Soporte  
Wspornik

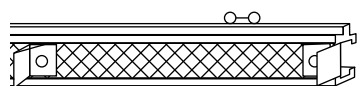

303090  
Profilo velcrato con traini e supporti scorrevoli  
Velcro bar with sliding rings and tracks  
Profil de velcro avec glisseurs et entraineurs  
Panelwagen inkl. Klettband  
Barra velcrada con correderas y remolques  
Profil na rzep z podporami i linką przesuwną

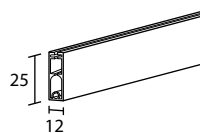

253120  
Peso  
Weight bar  
Barre de lestage  
Beschwerungsprofil  
Perfil contrapeso  
Obciążnik



253135  
Tappo per peso  
Endcap for weight bar  
Bouchon pour barre de lestage  
Endkappe Für Beschwerungsprofil  
Tapón para contrapeso  
Zaślepka obciążnika

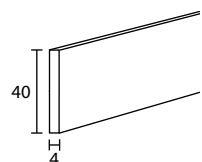

403190  
Peso interno  
Internal weight  
Barre de lestage interne  
Interne Beschwerungsprofil  
Perfil contrapeso interior  
Obciążnik wewnętrzny

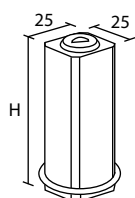

5630--  
Fiocco piatto  
Flat weight  
Contrepoids plat  
Schnurbeschwerer  
Contrapeso plano  
Obciążnik płaski

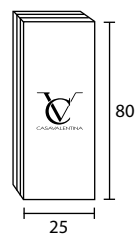

513099  
Maniglia  
Handle  
Poignée  
Klinke  
Manivela  
Raczka

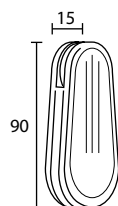

5010  
Fiocco in plastica ABS  
Plastic cord weight  
Contrepoids en plastique  
Schnurbeschwerer aus "ABS"  
Contrapeso de plástico  
Obciążnik plastikowy

Vie = Ways - Voies - Schiene - Vías - Biegi

| Cod. |     | 373998 | 573998 |
|------|-----|--------|--------|
| FIN  | Vie | 3 - 4  | 5      |

| Cod. |        | 303090 |
|------|--------|--------|
| FIN  | L - mt | 1      |

| Cod.    |        | 253120 | 253135 |
|---------|--------|--------|--------|
| FIN     | L - mt | 1      |        |
| 25      |        |        |        |
| 65 - 67 |        |        |        |
| 81 - 87 |        |        |        |

| Cod.    |                  | 403190 | 563007 | 563008 |
|---------|------------------|--------|--------|--------|
| FIN     | L - mt<br>H - mm | 1      | 80     | 100    |
| 25      |                  |        |        |        |
| 65 - 67 |                  |        |        |        |
| 81 - 87 |                  |        |        |        |

| Cod.    |  | 513099 | 5010 |
|---------|--|--------|------|
| FIN     |  |        |      |
| 25      |  |        |      |
| 65 - 67 |  |        |      |
| 81 - 87 |  |        |      |



# MOIRA

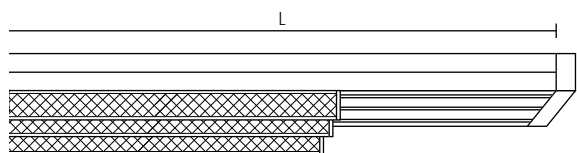

Scorritenda completo a soffitto - 3 vie  
 Complete curtain set with ceiling bracket - 3 ways  
 Tringle complète à plafond - 3 voies  
 Komplette Deckengarnitur - 3läufig  
 Conjunto completo a techo - 3 vías  
 Karnisz kompletny do sufitu - 3 biegi

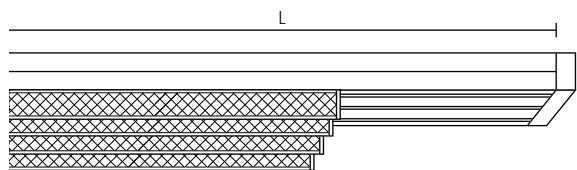

Scorritenda completo a soffitto - 4 vie  
 Complete curtain set with ceiling bracket - 4 ways  
 Tringle complète à plafond - 4 voies  
 Komplette Deckengarnitur - 4läufig  
 Conjunto completo a techo - 4 vías  
 Karnisz kompletny do sufitu - 4 biegi

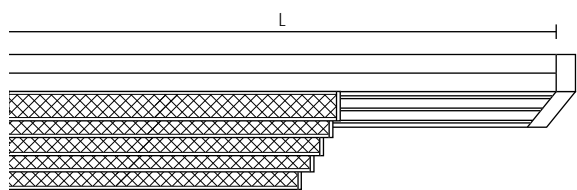

Scorritenda completo a soffitto - 5 vie  
 Complete curtain set with ceiling bracket - 5 ways  
 Tringle complète à plafond - 5 voies  
 Komplette Deckengarnitur - 5läufig  
 Conjunto completo a techo - 5 vías  
 Karnisz kompletny do sufitu - 5 biegi

**FIN** = Finitura - Finish - Finition - Fertigung - Acabado - Wykonczenie  
**Vie** = Vie - Ways - Voies - Schiene - Vías - Biegi  
**Port.** = Portateli - Sliding profiles - Porte-panneaux - Stoffhalter - Porta paneles - Walek  
**Sup.** = Supporti - Brackets - Supports - Träger - Soportes - Wsporniki  
**Peso** = Weight - Barre de lestage - Beschwerungsprofil - Perfil contrapeso - Obciążnik

| <b>Cod. 373T98</b>               |           |            |            |            |            |            |            |            |            |
|----------------------------------|-----------|------------|------------|------------|------------|------------|------------|------------|------------|
| <b>FIN</b>                       | <b>cm</b> | <b>140</b> | <b>160</b> | <b>180</b> | <b>200</b> | <b>220</b> | <b>250</b> | <b>300</b> | <b>340</b> |
| <b>25 - 67 **</b>                |           |            |            |            |            |            |            |            |            |
| <b>81 - 312 *</b>                |           |            |            |            |            |            |            |            |            |
| <b>Port. 3</b>                   | <b>cm</b> | <b>52</b>  | <b>60</b>  | <b>66</b>  | <b>72</b>  | <b>78</b>  | <b>90</b>  | <b>106</b> | <b>120</b> |
| <b>Sup.</b>                      | <b>n.</b> | <b>2</b>   | <b>2</b>   | <b>3</b>   | <b>3</b>   | <b>3</b>   | <b>3</b>   | <b>4</b>   | <b>4</b>   |
| <b>25 - 67 Peso Cod. 253120</b>  | <b>n.</b> | <b>3</b>   | <b>3</b>   | <b>3</b>   | <b>3</b>   | <b>3</b>   | <b>3</b>   | <b>3</b>   | <b>3</b>   |
| <b>81 - 312 Peso Cod. 403190</b> | <b>n.</b> | <b>3</b>   | <b>3</b>   | <b>3</b>   | <b>3</b>   | <b>3</b>   | <b>3</b>   | <b>3</b>   | <b>3</b>   |

\*\* Terminali e peso esterno da 25mm in alluminio - Finials and external weight 25mm in aluminium  
 Embouts et lestage 25mm en aluminium - Endkappe und Aussenbeschwerung 25mm aus Aluminium  
 Tapones y contrapeso exterior 25mm en aluminio - Zatyczka i obciążnik zewnętrzny 25 mm z aluminium  
 \* Terminali in ABS e peso interno 40x4mm - Finials in ABS and internal weight 40x4mm  
 Embouts en ABS et lestage interne 40x4mm - Endkappe aus ABS und Innenbeschwerung 40x4mm  
 Tapones en ABS y contrapeso interior 40x4mm - Zatyczka ABS i obciążnik wewnętrzny 40x4mm

| <b>Cod. 473T98</b>               |           |  |            |            |            |            |            |            |  |
|----------------------------------|-----------|--|------------|------------|------------|------------|------------|------------|--|
| <b>FIN</b>                       | <b>cm</b> |  | <b>180</b> | <b>200</b> | <b>220</b> | <b>250</b> | <b>300</b> | <b>340</b> |  |
| <b>25 - 67 **</b>                |           |  |            |            |            |            |            |            |  |
| <b>81 - 312 *</b>                |           |  |            |            |            |            |            |            |  |
| <b>Port. 4</b>                   | <b>cm</b> |  | <b>51</b>  | <b>56</b>  | <b>61</b>  | <b>69</b>  | <b>81</b>  | <b>91</b>  |  |
| <b>Sup.</b>                      | <b>n.</b> |  | <b>3</b>   | <b>3</b>   | <b>3</b>   | <b>3</b>   | <b>4</b>   | <b>4</b>   |  |
| <b>25 - 67 Peso Cod. 253120</b>  | <b>n.</b> |  | <b>4</b>   | <b>4</b>   | <b>4</b>   | <b>4</b>   | <b>4</b>   | <b>4</b>   |  |
| <b>81 - 312 Peso Cod. 403190</b> | <b>n.</b> |  | <b>4</b>   | <b>4</b>   | <b>4</b>   | <b>4</b>   | <b>4</b>   | <b>4</b>   |  |

\*\* Terminali e peso esterno da 25mm in alluminio - Finials and external weight 25mm in aluminium  
 Embouts et lestage 25mm en aluminium - Endkappe und Aussenbeschwerung 25mm aus Aluminium  
 Tapones y contrapeso exterior 25mm en aluminio - Zatyczka i obciążnik zewnętrzny 25 mm z aluminium  
 \* Terminali in ABS e peso interno 40x4mm - Finials in ABS and internal weight 40x4mm  
 Embouts en ABS et lestage interne 40x4mm - Endkappe aus ABS und Innenbeschwerung 40x4mm  
 Tapones en ABS y contrapeso interior 40x4mm - Zatyczka ABS i obciążnik wewnętrzny 40x4mm

| <b>Cod. 573T98</b>               |           |  |  |            |            |            |            |  |  |
|----------------------------------|-----------|--|--|------------|------------|------------|------------|--|--|
| <b>FIN</b>                       | <b>cm</b> |  |  | <b>220</b> | <b>250</b> | <b>300</b> | <b>340</b> |  |  |
| <b>25 - 67 **</b>                |           |  |  |            |            |            |            |  |  |
| <b>81 - 312 *</b>                |           |  |  |            |            |            |            |  |  |
| <b>Port. 5</b>                   | <b>cm</b> |  |  | <b>50</b>  | <b>56</b>  | <b>66</b>  | <b>74</b>  |  |  |
| <b>Sup.</b>                      | <b>n.</b> |  |  | <b>3</b>   | <b>3</b>   | <b>4</b>   | <b>4</b>   |  |  |
| <b>25 - 67 Peso Cod. 253120</b>  | <b>n.</b> |  |  | <b>5</b>   | <b>5</b>   | <b>5</b>   | <b>5</b>   |  |  |
| <b>81 - 312 Peso Cod. 403190</b> | <b>n.</b> |  |  | <b>5</b>   | <b>5</b>   | <b>5</b>   | <b>5</b>   |  |  |

\*\* Terminali e peso esterno da 25mm in alluminio - Finials and external weight 25mm in aluminium  
 Embouts et lestage 25mm en aluminium - Endkappe und Aussenbeschwerung 25mm aus Aluminium  
 Tapones y contrapeso exterior 25mm en aluminio - Zatyczka i obciążnik zewnętrzny 25 mm z aluminium  
 \* Terminali in ABS e peso interno 40x4mm - Finials in ABS and internal weight 40x4mm  
 Embouts en ABS et lestage interne 40x4mm - Endkappe aus ABS und Innenbeschwerung 40x4mm  
 Tapones en ABS y contrapeso interior 40x4mm - Zatyczka ABS i obciążnik wewnętrzny 40x4mm