





Fin. A5B2 - Ø85

Tortora perlato - Old america
 Pearled dove colored - Old america
 Tourterelle perlé - Old america

Turteltaube perliert - Old america
 Tórtola perlado - Old america
 Szaro-orzechowy perlowy - Old america



Fin. 25B1 - Ø85

Alluminio colore acciaio satinato - Aspen
 Anodized aluminium steel color - Aspen
 Aluminium anodisé coloris acier - Aspen

Aluminium eloxiert Stahl Farbe - Aspen
 Aluminio anodizado color acero - Aspen
 Aluminium w kolorze stali matowe - Aspen



ERINEA WOOD

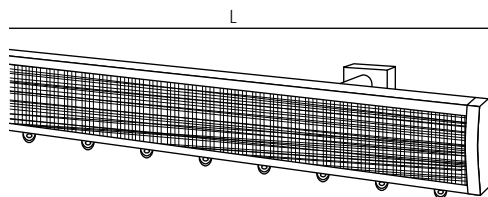

Scorritenda completo a parete
Complete curtain set
Tringle complète
Komplette Garnitur
Conjunto completo
Karnisz kompletny montaż do ściany

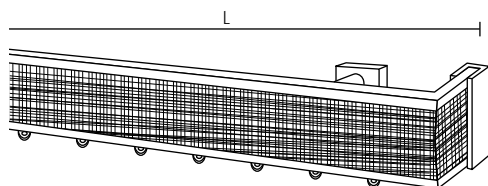

Scorritenda completo a parete
Complete curtain set
Tringle complète
Komplette Garnitur
Conjunto completo
Karnisz kompletny montaż do ściany

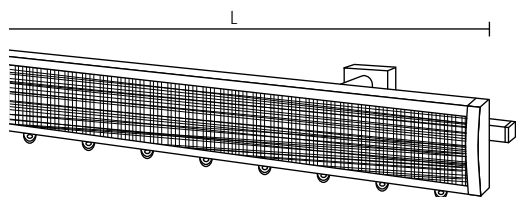

Scorritenda completo doppio a parete
Complete double curtain set
Tringle complète double pose murale
Komplette Doppelgarnitur
Conjunto completo doble a pared
Karnisz podwójny kompletny montaż do ściany

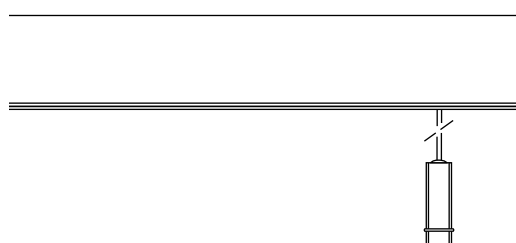

FIN. = Finitura - Finish - Finition - Fertigung - Acabado - Wykonczenie
Ang. = Angoli - Angles - Retours - Kanten - Ângulos - Naroznikiem
Scor. = Scorrevoli - Runners - Glisseurs - Gleiter - Correderas - Ślizgacze
Sup. = Supporti - Brackets - Supports - Träger - Soportes - Wsporniki

Cod. 853A01		Ø 85 mm								
FIN	cm	120	140	160	180	200	220	250	300	340
25 - 312										
67										
A2 - A3 - A4 - A5 - A6										
25 B1 - B2 - B3 - B4										
67 B1 - B2 - B3 - B4										
A6 B1 - B2 - B3 - B4										
Scor. Cod. 1000	n.	16	20	22	24	28	30	36	42	46
Sup. cm 21	n.	2	2	2	2	2	2	3	3	3

Cod. 853B01		Ø 85 mm								
FIN	cm	120	140	160	180	200	220	250	300	340
25 - 312										
67										
A2 - A3 - A4 - A5 - A6										
25 B1 - B2 - B3 - B4										
67 B1 - B2 - B3 - B4										
A6 B1 - B2 - B3 - B4										
Ang. cm 11										
Scor. Cod. 1000	n.	16	20	22	24	28	30	36	42	46
Sup.	n.	2	2	2	2	2	2	3	3	3

Cod. 853L01		Ø 85 mm								
FIN	cm	120	140	160	180	200	220	250	300	340
25 - 312										
67										
A2 - A3 - A4 - A5 - A6										
25 B1 - B2 - B3 - B4										
67 B1 - B2 - B3 - B4										
A6 B1 - B2 - B3 - B4										
Scor. Cod. 1000	n.	16/16	20/20	22/22	24/24	28/28	30/30	36/36	42/42	46/46
Sup. cm 21	n.	2	2	2	2+1	2+1	2+1	3	3	3

Maggiorazione movimento a corda - Surcharge for corded systems - Supplément pour tirage
Zuschlag für Schnurbedienung - Suplemento por cuerda - Dodatkowo koszt mechanizmu

cm	120	140	160	180	200	220	250	300	340
----	-----	-----	-----	-----	-----	-----	-----	-----	-----

ERINEA WOOD

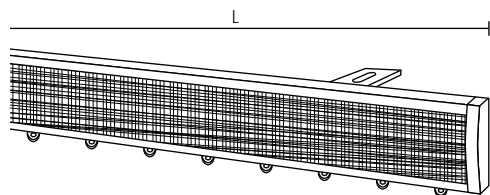

Scorritenda completo a soffitto
Complete curtain set with ceiling bracket
Tringle complète à plafond
Komplette Deckengarnitur
Conjunto completo a techo
Karnisz kompletny do sufitu

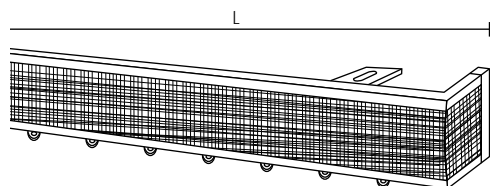

Scorritenda completo a soffitto
Complete curtain set with ceiling bracket
Tringle complète à plafond
Komplette Deckengarnitur
Conjunto completo a techo
Karnisz kompletny do sufitu

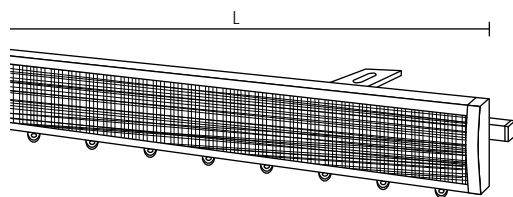

Scorritenda completo doppio a soffitto
Complete double curtain set with ceiling bracket
Tringle complète double à plafond
Komplette Decken-Doppelgarnitur
Conjunto completo doble a techo
Karnisz kompletny podwojny do sufitu

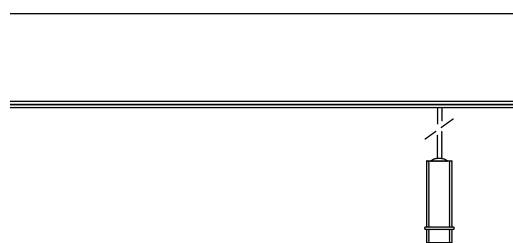

FIN. = Finitura - Finish - Finition - Fertigung - Acabado - Wykonczenie
Ang. = Angoli - Angles - Retours - Kanten - Ángulos - Naroznikamiem
Scor. = Scorrevoli - Runners - Glisseurs - Gleiter - Correderas - Ślizgacze
Sup. = Supporti - Brackets - Supports - Träger - Soportes - Wsporniki

Cod. 853T01		∅ 85 mm								
FIN	cm	120	140	160	180	200	220	250	300	340
25 - 312										
67										
A2 - A3 - A4 - A5 - A6										
25 B1 - B2 - B3 - B4										
67 B1 - B2 - B3 - B4										
A6 B1 - B2 - B3 - B4										
Scor. Cod. 1000	n.	16	20	22	24	28	30	36	42	46
Sup.	n.	2	2	2	2	2	2	3	3	3

Cod. 853P01		∅ 85 mm								
FIN	cm	120	140	160	180	200	220	250	300	340
25 - 312										
67										
A2 - A3 - A4 - A5 - A6										
25 B1 - B2 - B3 - B4										
67 B1 - B2 - B3 - B4										
A6 B1 - B2 - B3 - B4										
Ang. cm 11										
Scor. Cod. 1000	n.	16	20	22	24	28	30	36	42	46
Sup.	n.	2	2	2	2	2	2	3	3	3

Cod. 853U01		∅ 85 mm								
FIN	cm	120	140	160	180	200	220	250	300	340
25 - 312										
67										
A2 - A3 - A4 - A5 - A6										
25 B1 - B2 - B3 - B4										
67 B1 - B2 - B3 - B4										
A6 B1 - B2 - B3 - B4										
Scor. Cod. 1000	n.	16/16	20/20	22/22	24/24	28/28	30/30	36/36	42/42	46/46
Sup.	n.	2	2	2	2+1	2+1	2+1	3	3	3

Maggiorazione movimento a corda - Surcharge for corded systems - Supplément pour tirage
Zuschlag für Schnurbedienung - Suplemento por cuerda - Dodatkowo koszt mechanizmu

cm	120	140	160	180	200	220	250	300	340
-----------	------------	------------	------------	------------	------------	------------	------------	------------	------------

ERINEA WOOD

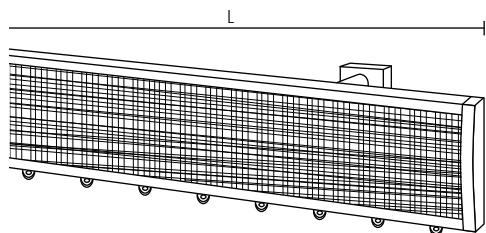

Scorritenda completo a parete
Complete curtain set
Tringle complète
Komplette Garnitur
Conjunto completo
Karnisz kompletny montaż do ściany

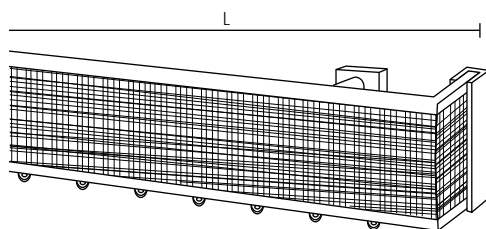

Scorritenda completo a parete
Complete curtain set
Tringle complète
Komplette Garnitur
Conjunto completo
Karnisz kompletny montaż do ściany

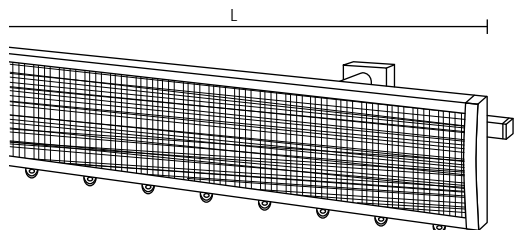

Scorritenda completo doppio a parete
Complete double curtain set
Tringle complète double pose murale
Komplette Doppelgarnitur
Conjunto completo doble a pared
Karnisz podwójny kompletny montaż do ściany

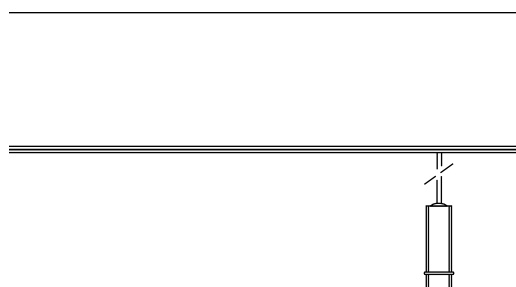

FIN. = Finitura - Finish - Finition - Fertigung - Acabado - Wykonczenie
Ang. = Angoli - Angles - Retours - Kanten - Ângulos - Naroznikami
Scor. = Scorrevoli - Runners - Glisseurs - Gleiter - Correderas - Ślizgacze
Sup. = Supporti - Brackets - Supports - Träger - Soportes - Wsporniki

Cod. 133A01		Ø 135 mm								
FIN	cm	120	140	160	180	200	220	250	300	340
25 - 312										
67										
A2 - A3 - A4 - A5 - A6										
25 B1 - B2 - B3 - B4										
67 B1 - B2 - B3 - B4										
A6 B1 - B2 - B3 - B4										
Scor. Cod. 1000	n.	16	20	22	24	28	30	36	42	46
Sup. cm 21	n.	2	2	2	2	2	2	3	3	3

Cod. 133B01		Ø 135 mm								
FIN	cm	120	140	160	180	200	220	250	300	340
25 - 312										
67										
A2 - A3 - A4 - A5 - A6										
25 B1 - B2 - B3 - B4										
67 B1 - B2 - B3 - B4										
A6 B1 - B2 - B3 - B4										
Ang. cm 11										
Scor. Cod. 1000	n.	16	20	22	24	28	30	36	42	46
Sup.	n.	2	2	2	2	2	2	3	3	3

Cod. 133L01		Ø 135 mm								
FIN	cm	120	140	160	180	200	220	250	300	340
25 - 312										
67										
A2 - A3 - A4 - A5 - A6										
25 B1 - B2 - B3 - B4										
67 B1 - B2 - B3 - B4										
A6 B1 - B2 - B3 - B4										
Scor. Cod. 1000	n.	16/16	20/20	22/22	24/24	28/28	30/30	36/36	42/42	46/46
Sup. cm 21	n.	2	2	2	2+1	2+1	2+1	3	3	3

Maggiorazione movimento a corda - Surcharge for corded systems - Supplément pour tirage
Zuschlag für Schnurbedienung - Suplemento por cuerda - Dodatkowo koszt mechanizmu

cm	120	140	160	180	200	220	250	300	340
----	-----	-----	-----	-----	-----	-----	-----	-----	-----

ERINEA WOOD

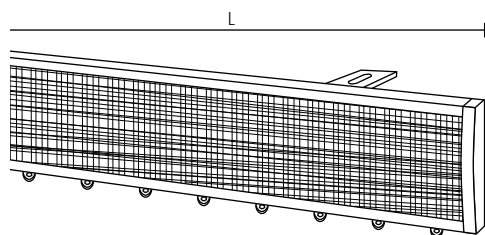

Scorritenda completo a soffitto
Complete curtain set with ceiling bracket
Tringle complète à plafond
Komplette Deckengarnitur
Conjunto completo a techo
Karnisz kompletny do sufitu

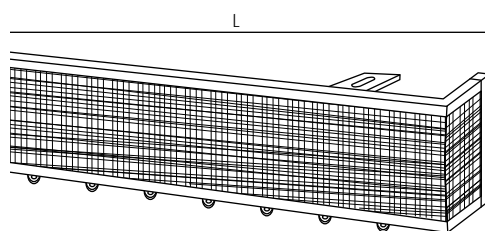

Scorritenda completo a soffitto
Complete curtain set with ceiling bracket
Tringle complète à plafond
Komplette Deckengarnitur
Conjunto completo a techo
Karnisz kompletny do sufitu

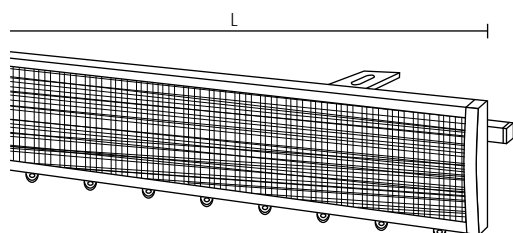

Scorritenda completo doppio a soffitto
Complete double curtain set with ceiling bracket
Tringle complète double à plafond
Komplette Decken-Doppelgarnitur
Conjunto completo doble a techo
Karnisz kompletny podwojny do sufitu



FIN. = Finitura - Finish - Finition - Fertigung - Acabado - Wykonczenie
Ang. = Angoli - Angles - Retours - Kanten - Ángulos - Naroznikamiem
Scor. = Scorrevoli - Runners - Glisseurs - Gleiter - Correderas - Ślizgacze
Sup. = Supporti - Brackets - Supports - Träger - Soportes - Wsporniki

Cod. 133T01		∅ 135 mm								
FIN	cm	120	140	160	180	200	220	250	300	340
25 - 312										
67										
A2 - A3 - A4 - A5 - A6										
25 B1 - B2 - B3 - B4										
67 B1 - B2 - B3 - B4										
A6 B1 - B2 - B3 - B4										
Scor. Cod. 1000	n.	16	20	22	24	28	30	36	42	46
Sup.	n.	2	2	2	2	2	2	3	3	3

Cod. 133P01		∅ 135 mm								
FIN	cm	120	140	160	180	200	220	250	300	340
25 - 312										
67										
A2 - A3 - A4 - A5 - A6										
25 B1 - B2 - B3 - B4										
67 B1 - B2 - B3 - B4										
A6 B1 - B2 - B3 - B4										
Ang. cm 11										
Scor. Cod. 1000	n.	16	20	22	24	28	30	36	42	46
Sup.	n.	2	2	2	2	2	2	3	3	3

Cod. 133U01		∅ 135 mm								
FIN	cm	120	140	160	180	200	220	250	300	340
25 - 312										
67										
A2 - A3 - A4 - A5 - A6										
25 B1 - B2 - B3 - B4										
67 B1 - B2 - B3 - B4										
A6 B1 - B2 - B3 - B4										
Scor. Cod. 1000	n.	16/16	20/20	22/22	24/24	28/28	30/30	36/36	42/42	46/46
Sup.	n.	2	2	2	2+1	2+1	2+1	3	3	3

Maggiorazione movimento a corda - Surcharge for corded systems - Supplément pour tirage
Zuschlag für Schnurbedienung - Suplemento por cuerda - Dodatkowo koszt mechanizmu

cm	120	140	160	180	200	220	250	300	340
-----------	------------	------------	------------	------------	------------	------------	------------	------------	------------

ERINEA WOOD

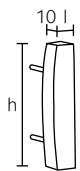

--3121
Tappo
Endcap
Bouchon

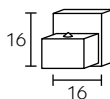

163045
Endkappe
Tapón
Zatyczka

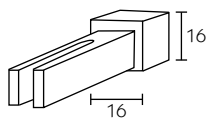

163145
Tappo con carrucola
Endcap for cord
Bouchon pour tirage

Endkappe mit Lenkung
Tapón para cuerda
Zatyczka z blokiem

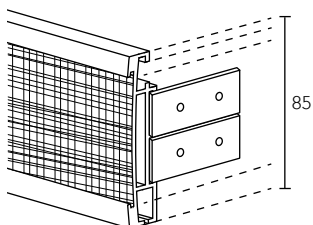

9231--
Angolare
Angle
Retour

Kante
Ángulo
Narozny

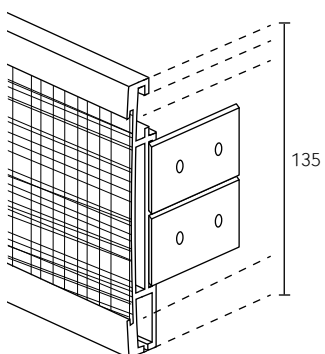

1331--
Angolare
Angle
Retour

Kante
Ángulo
Narozny

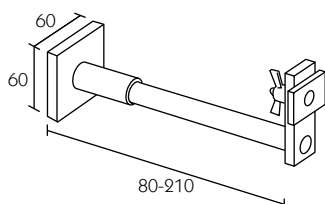

513338
Supporto
Bracket
Support

Träger
Soporte
Wspornik

Cod.		853121SX / DX	133121SX / DX	163045
FIN	h - mm	85	135	16
	l - mm	19,5	20	16
25 - 312				
67				
A2 - A3 - A4 - A5 - A6				

Cod.		163145
FIN	h - mm	
25 - 312		
67		
A2 - A3 - A4 - A5 - A6		

Cod.		923135SX / DX	923145SX / DX	923155SX / DX
FIN	l - mm	110	180	230
25 - 312				
67				
A2 - A3 - A4 - A5 - A6				
25 B1 - B2 - B3 - B4				
67 B1 - B2 - B3 - B4				
A6 B1 - B2 - B3 - B4				

Cod.		133135SX / DX	133145SX / DX	133155SX / DX
FIN	l - mm	110	180	230
25 - 312				
67				
A2 - A3 - A4 - A5 - A6				
25 B1 - B2 - B3 - B4				
67 B1 - B2 - B3 - B4				
A6 B1 - B2 - B3 - B4				

Cod.		513338
FIN		
25 - 312		
67		
A2 - A3 - A4 - A5 - A6		

Components

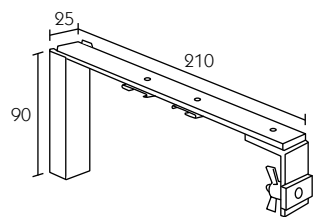

5533--

Supporto doppio con cover
Double bracket with cover
Support double avec couverture
Doppelträger mit Deckel
Soporte doble con cover
Wspornik podwójny z nakładką

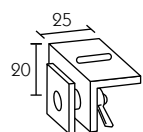

--3018

Supporto a soffitto
Ceiling bracket
Support à plafond
Deckenträger
Soporte a techo
Wspornik do sufitu



163299

Supporto a soffitto per binario
Ceiling hanger for tracks
Accroche pour plafond
Deckenträger für Schiene
Gancho a techo
Dodatkowe zahaczenie dla szyny

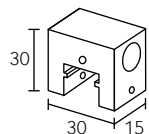

163011

Aggancio binario
Tracks' hanger
Accroche pour rail
Schiene Koppelung
Enganche riel
Haczyk toru

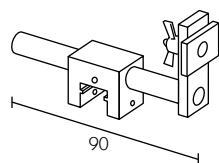

853997

Supporto intermedio doppio
Central double bracket
Support intermédiaire double
Mitteldoppelträger
Soporte intermedio doble
Wspornik środkowy podwójny

Cod.		553309	553319	553329
FIN	l - mm	90	160	210
25 - 312				
67				
A2 - A3 - A4 - A5 - A6				

Cod.		853018	133018
FIN			
25 - 312			
67			
A2 - A3 - A4 - A5 - A6			

Cod.		163299
FIN		
BNL		

Cod.		163011
FIN		
25 - 312		
67		
A2 - A3 - A4 - A5 - A6		

Cod.		853997
FIN		
25 - 312		
67		
A2 - A3 - A4 - A5 - A6		

ERINEA WOOD

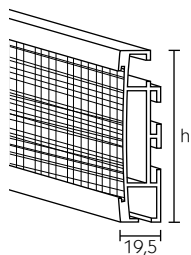

853210 133100

Profilo
Profile
Profil
Profil
Perfil
Profil

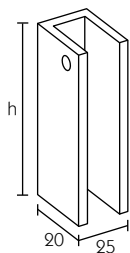

--3102

Rosetta a muro
Recess bracket
Naissance murale
Wandlager
Soporte lateral
Podkładka do muru

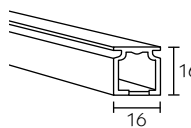

163200

Profilo
Profile
Profil
Profil
Perfil
Profil

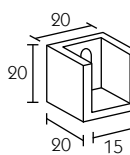

163001

Rosetta a muro
Recess bracket
Naissance murale
Wandlager
Soporte lateral
Podkładka do muru

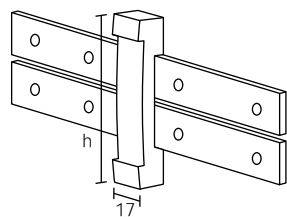

--3121CX

Tappo per giunzione
Endcap for joiner
Bouchon pour jonction
Endkappe Für Verbindungsstück
Tapón para empalme
Korek do lacznika

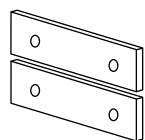

563087

Giunzione
Junction
Jonction

Verbinder
Enchufe
Łącznik

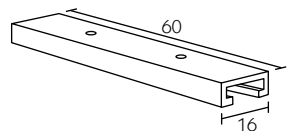

563088

Giunzione per binario
Juncton for rail
Jonction pour rail

Schiene-Verbinder
Empalme para riel
Łącznik do szyny

Cod.	853210	133100	853102SX / DX	133102SX / DX
FIN	85	135	85	135
25 - 312				
67				
A2 - A3 - A4 - A5 - A6				
25 B1 - B2 - B3 - B4				
67 B1 - B2 - B3 - B4				
A6 B1 - B2 - B3 - B4				

Cod.	163200	163001SX / DX
FIN		
25 - 312		
67		
A2 - A3 - A4 - A5 - A6		

Cod.	853121CX	133121CX
FIN	85	135
25 - 312		
67		
A2 - A3 - A4 - A5 - A6		

Cod.	563087
FIN	

Cod.	563088
FIN	
25 - 312	
67	
A2 - A3 - A4 - A5 - A6	

Components

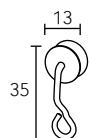

524056
Scorrevoli
Runners
Glisseurs



1000
Gleiter
Correderas
Slizgacze

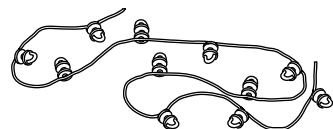

1000--
Scorrevoli
Runners
Glisseurs

Gleiter
Correderas
Slizgacze



1001
Scorrevole
Runner
Glisseur
Gleiter
Corredera
Slizgacze

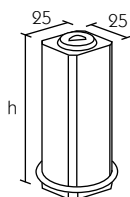

5630--
Fiocco piatto
Flat weight
Contrepoids plat
Schnurbeschwerer
Contrapeso plano
Obciążnik płaski

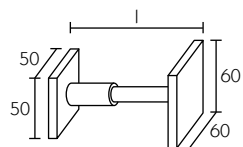

5130--
Fermatenda
Holdback
Porte-embrasse

Raffhalter
Alzapaño
Przytrzymanie franki

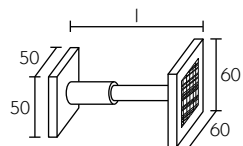

5130--
Fermatenda
Holdback
Porte-embrasse

5130--
Raffhalter
Alzapaño
Przytrzymanie franki

Cod.	524056	1000
FIN		
98		

Cod.	1000P6*	1000P8**
FIN		
Euro/mt		

* Scorrevoli passo 60 mm - Runners each 60 mm - Glisseurs tous les 60 mm - Gleiter je 60 mm - Correderas cada 60 mm - Slizgi co 60 mm
** Scorrevoli passo 80 mm - Runners each 80 mm - Glisseurs tous les 80 mm - Gleiter je 80 mm - Correderas cada 80 mm - Slizgi co 80 mm

Cod.	1001	563007	563008
FIN	h - mm	80	100
	l - mm		
25 - 312			
67			
A2 - A3 - A4 - A5 - A6			

Cod.	513091	513092	513093
FIN	h - mm		
	l - mm	100	200
25 - 312			
67			
A2 - A3 - A4 - A5 - A6			

Cod.	513081	513082	513083
FIN	l - mm	100	200
25 B1 - B2 - B3 - B4			
67 B1 - B2 - B3 - B4			
A6 B1 - B2 - B3 - B4			