

Cod. 923U19...SX / DX*

Sistema a parete per pacchetto
Wall balloon shade system

Système de face store bouillonné
Raffrolsystem für Wandmontage

Sistema pared para pacchetto
System ścienny do marszczenia pionowego

Cod.	923419 DX/SX	923439 DX/SX	923449 DX/SX	923479 DX/SX
A - mm				
H - mm				

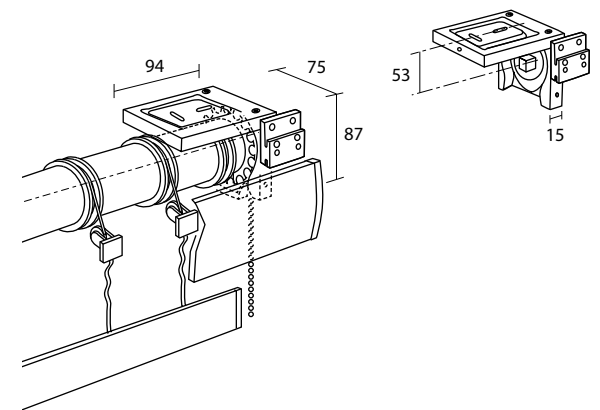
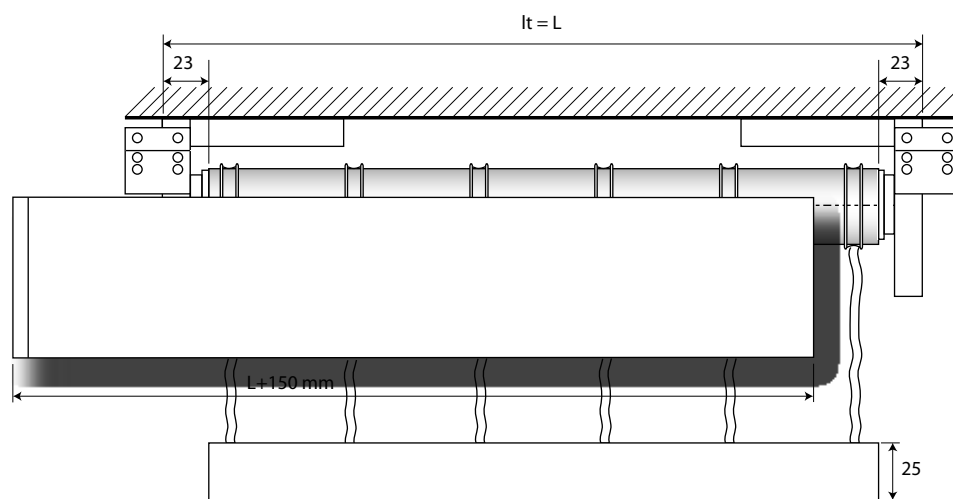

Cod. 923Q29...SX / DX*

Sistema a soffitto per pacchetto
Ceiling balloon shade system

Système plafond store bouillonné
Raffrolsystem für Deckenmontage

Sistema techo para pacchetto
System sufitowy do marszczenia pionowego



25



67



312

A = Sporgenza supporto - Bracket's projection - Retour support - Träger Abstand - Escuadra de separación - Występ wspornika
H = Distanza parete - Wall distance - Retour du mur - Wand Abstand - Distancia pared - Odległość od ściany
L = Larghezza sistema (cm) - System width (cm) - Largeur système (cm) - Gesamtbreite (cm) - Ancho sistema (cm) - Szerokość systemu (cm)
lt = Larghezza singolo tessuto - Fabric width per unit - Largeur chaque toile - Stoff Breite - Ancho de cada tejido - Szerokość pojedynczej tkaniny

FIN 25 - 312

Supporti - Brackets - Supports - Träger - Soportes - Wsporniki Cod. 923419 - 923429

L - cm CT	80 C	100 C	120 C	140 C	160 C	180 C
80 C - cm						
100						
120						
140						
160						
180						
200						
220						
240						
260						
280						
n. Cad	3	3	4	4	4	4

* Il sistema monta solo i tessuti Nizza e Praga - For this system only fabrics Nizza and Praga - Pour ce système uniquement toiles Nizza and Praga
 Das System montiert nur die Stoffe Nizza und Praga - Para este sistema, sólo telas Nizza y Praga - Jedyne tkaniny używane w tym systemie to Nizza i Praga

L - cm CT	200 C	220 C	240 C	260 C	280 C	300 C
80 C - cm						
100						
120						
140						
160						
180						
200						
220						
240						
260						
280						
n. Cad	6	6	7	7	8	8

* Il sistema monta solo i tessuti Nizza e Praga - For this system only fabrics Nizza and Praga - Pour ce système uniquement toiles Nizza and Praga
 Das System montiert nur die Stoffe Nizza und Praga - Para este sistema, sólo telas Nizza y Praga - Jedyne tkaniny używane w tym systemie to Nizza i Praga

Maggiorazioni - Surcharges - Suppléments - Zuschläge - Suplementos - Dodatkowa opłata

L - cm	80	100	120	140	160	180	200	220	240	260	280	300
67												

IDRA

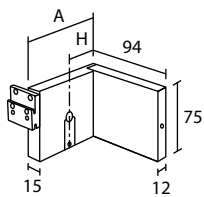

9234--

Lato perno
Pivot side
Côté pivot

Träger Achseseite
Lado pivote
Strona czopa

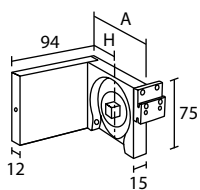

9234--

Lato catena
Chain side
Côté chainette

Träger Ketteseite
Lado cadena
Strona łańcuszka

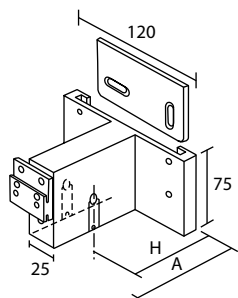

923614 923664
Intermedio P/P
Middle P/P
Intermédiaire P/P
Mittelträger P/P
Intermedio P/P
Środkowy P/P

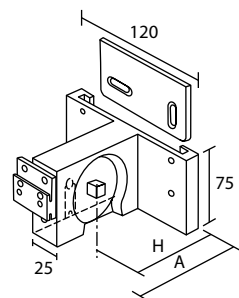

923615 923665
Intermedio P/C
Middle P/C
Intermédiaire P/C
Mittelträger P/C
Intermedio P/C
Środkowy P/C

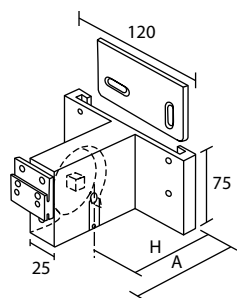

923616 923666
Intermedio C/P
Middle C/P
Intermédiaire C/P
Mittelträger C/P
Intermedio C/P
Środkowy C/P

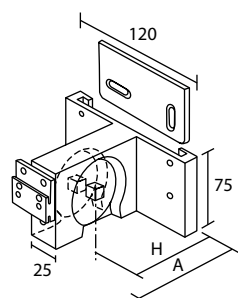

923617 923667
Intermedio C/C
Middle C/C
Intermédiaire C/C
Mittelträger C/C
Intermedio C/C
Środkowy C/C

P = Lato perno - Pivot side - Côté pivot - Achseseite - Lado Pivote - Strona czopa
C = Lato catena - Chain side - Côté chainette - Ketteseite - Lado cadena - Strona łańcuszka

SISTEMA A PARETE - WALL SYSTEM - SYSTÈME DE FACE - WANDMONTAGE - SISTEMA PARED - SYSTEM ŚCIENNY

Cod.		923418SX / DX	923438SX / DX	923448SX / DX	923478SX / DX
FIN	A - mm	94	144	192	242
	H - mm	53	103	151	201
25 - 312					
67					

Cod.		923419SX / DX	923439SX / DX	923449SX / DX	923479SX / DX
FIN	A - mm	94	144	192	242
	H - mm	53	103	151	201
25 - 312					
67					

Cod.		923614	923664	923615	923665
FIN	A - mm	94	144	94	144
	H - mm	53	103	53	103
25 - 312					
67					

Cod.		923616	923666	923617	923667
FIN	A - mm	94	144	94	144
	H - mm	53	103	53	103
25 - 312					
67					

IDRA

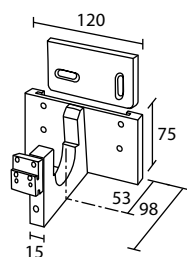

923609

Singolo passante
Bypassing
Single passant

Einzelträger vorübergehend
Intermedio pasante
Pojedynczy przelotowy

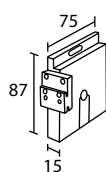

923698

Rosetta P
Recess bracket P
Naissance murale P
Wandlager P
Soporte lateral P
Podkładka okrągła P

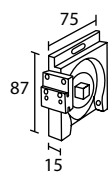

923699

Rosetta C
Recess bracket C
Naissance murale C
Wandlager C
Soporte lateral C
Podkładka okrągła C

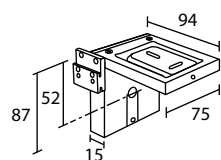

923428

Lato perno
Pivot side
Côté pivot
Träger Achseseite
Lado pivote
Strona czopa

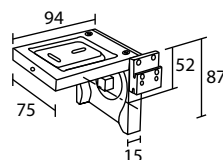

923429

Lato catena
Chain side
Côté chainette
Träger Ketteseite
Lado cadena
Strona łańcuszka

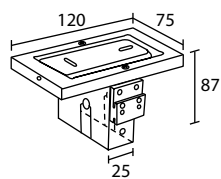

923624

Intermedio P/P
Middle P/P
Intermédiaire P/P
Mittelträger P/P
Intermedio P/P
Środkowy P/P

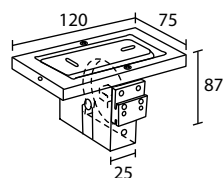

923625

Intermedio P/C
Middle P/C
Intermédiaire P/C
Mittelträger P/C
Intermedio P/C
Środkowy P/C

P = Lato perno - Pivot side - Côté pivot - Achseseite - Lado Pivote - Strona czopa
C = Lato catena - Chain side - Côté chainette - Ketteseite - Lado cadena - Strona łańcuszka

SISTEMA A PARETE - WALL SYSTEM - SYSTÈME DE FACE - WANDMONTAGE - SISTEMA PARED - SYSTEM ŚCIENNY

Cod.	923609
FIN	
25 - 312	
67	

Cod.	923698SX / DX	923699SX / DX
FIN		
25 - 312		
67		

SISTEMA A SOFFITTO - CEILING SYSTEM - SYSTÈME PLAFOND - DECKENMONTAGE - SISTEMA TECHO - SYSTEM SUFITOWY

Cod.	923428SX / DX	923429SX / DX
FIN		
25 - 312		
67		

Cod.	923624	923625
FIN		
25 - 312		
67		

IDRA

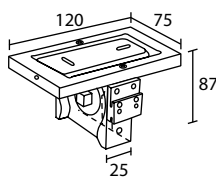

923626

Intermedio C/P
Middle C/P
Intermédiaire C/P
Mittelträger C/P
Intermedio C/P
Środkowy C/P

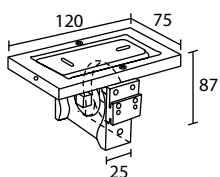

923627

Intermedio C/C
Middle C/C
Intermédiaire C/C
Mittelträger C/C
Intermedio C/C
Środkowy C/C

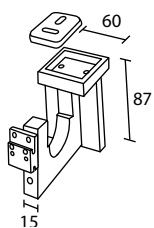

923659

Intermedio passante
Middle bypassing
Intermédiaire passant

Mittelträger vorübergehend
Intermedio pasante
Środkowy przelotowy

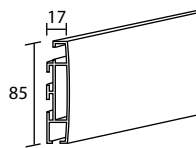

853200

Profilo frontale
Frontal profile
Profil frontal
Blende
Perfil frontal
Profil przedni

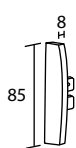

853111

Tappo
End cap
Bouchon
Endkappe
Tapón
Zatyczka

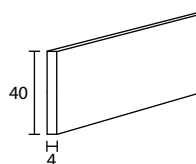

403190

Peso interno
Internal weight
Barre de lestage interne

Interne Beschwerungsprofil
Perfil contrapeso interior
Obciążnik wewnętrzny

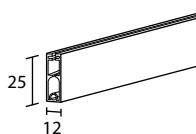

253120

Peso
Weight bar
Barre de lestage
Beschwerungsprofil
Perfil contrapeso
Obciążnik

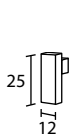

253135

Tappo per peso
Endcap for weight bar
Bouchon pour barre de lestage
Endkappe für Beschwerungsprofil
Tapón para contrapeso
Zaślepka obciążnika

P = Lato perno - Pivot side - Côté pivot - Achseseite - Lado Pivote - Strona czopa
C = Lato catena - Chain side - Côté chaînette - Ketteseite - Lado cadena - Strona łańcuszka

SISTEMA A SOFFITTO - CEILING SYSTEM - SYSTÈME PLAFOND - DECKENMONTAGE - SISTEMATECHO - SYSTEM SUFITOWY

Cod.	923626	923627
FIN		
25 - 312		
67		

Cod.	923659
FIN	
25 - 312	
67	

COMPONENTI - COMPONENTS - COMPOSANTS - ZUBEHÖR - COMPONENTES - CZĘŚCI

Cod.	853200	853111SX / DX
FIN	L - mt	1
25 - 312		
67		

Cod.	403190
FIN	L - mt
	1

Cod.	253120	253135
FIN	L - mt	1
25 - 312		
67		