



PERSEO Fin. | 25BB





# ARCADIA - CARENA - ERIS - PERSEO

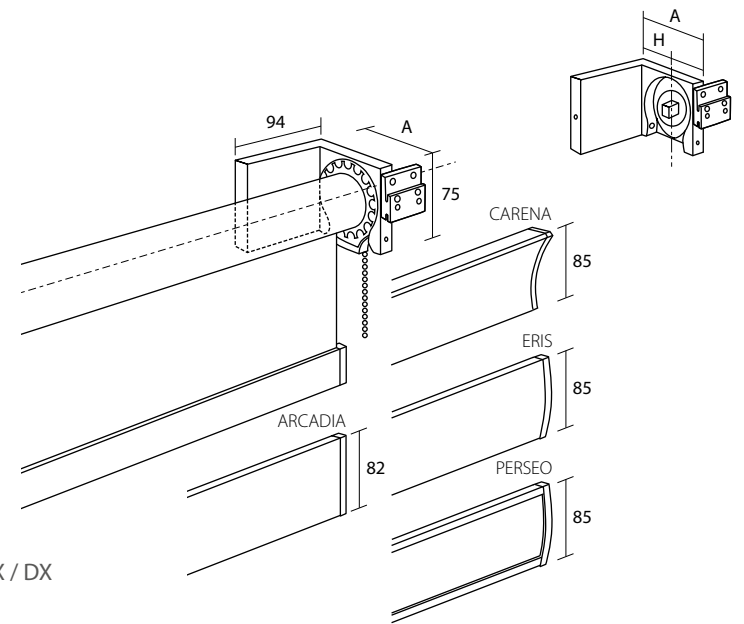
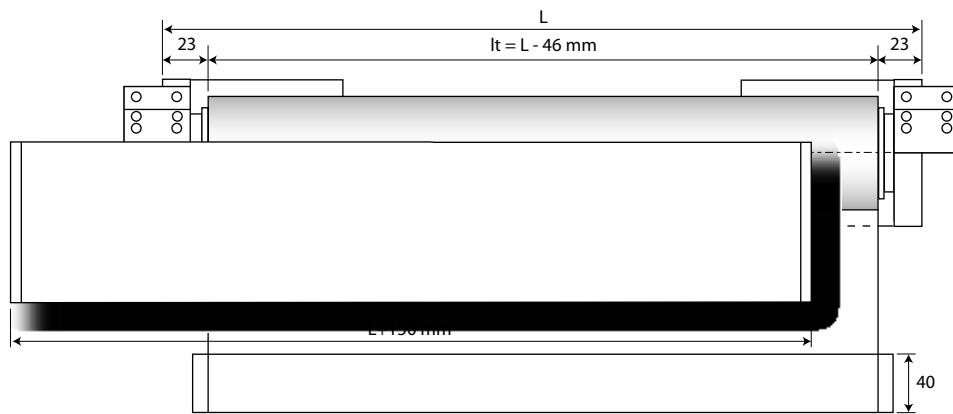
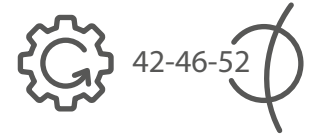

ARCADIA  
Cod. 623A19...SX / DX  
Sistema a parete  
Wall system

CARENA  
Cod. 813A19...SX / DX  
Système de face  
Wandmontage

ERIS  
Cod. 923A19...SX / DX  
Sistema pared  
System ścienny

PERSEO  
Cod. 943A19...SX / DX

Cod.	923419SX / DX	923439SX / DX	923449SX / DX	923479SX / DX
A - mm	94	144	192	242
H - mm	53	103	151	201

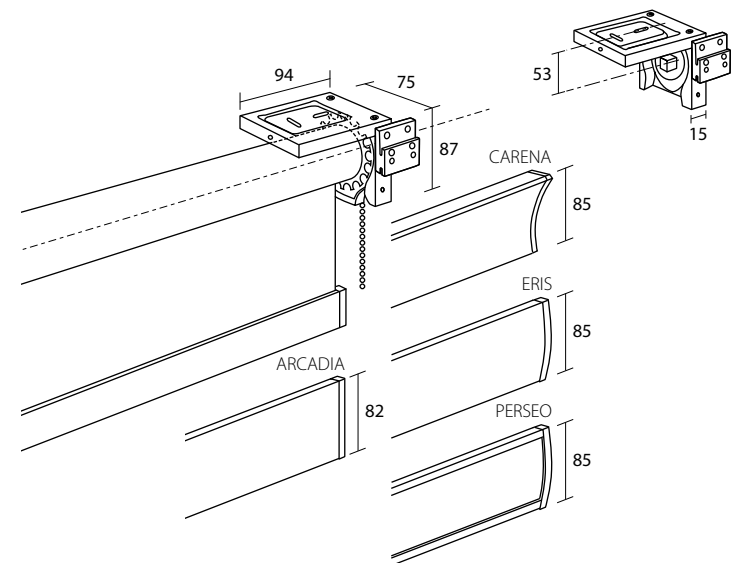
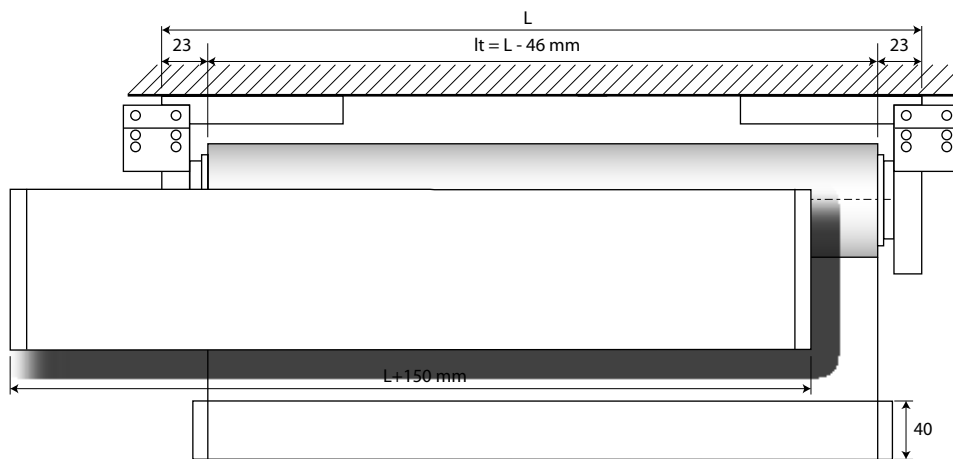

ARCADIA  
Cod. 623T19...SX / DX  
Sistema a soffitto  
Ceiling system

CARENA  
Cod. 813T29...SX / DX  
Système plafond  
Deckenmontage

ERIS  
Cod. 923T29...SX / DX  
Sistema techo  
System sufitowy

PERSEO  
Cod. 943T29...SX / DX



18

25

65

67

312

A2

A3

A5

A6

B1

B2

B3

B4

BB

BC

BN

IB

IN

IR

A = Sporgenza supporto - Bracket's projection - Retour support - Träger Abstand - Escuadra de separación - Występ wspornika

H = Distanza parete - Wall distance - Retour du mur - Wand Abstand - Distancia pared - Odległość od ściany

L = Larghezza sistema (cm) - System width (cm) - Largeur système (cm) - Gesamtbreite (cm) - Ancho sistema (cm) - Szerokość systemu (cm)

lt = Larghezza singolo tessuto - Fabric width per unit - Largeur chaque toile - Stoff Breite - Ancho de cada tejido - Szerokość pojedynczej tkaniny

FIN 18 - 25 - 312 - A2 - A3 - A5 - A6 - 3122 - A225 - A325 - A525 - A625

Supporti - Brackets - Supports - Träger - Soportes - Wsporniki Cod. 923419 - 923429

L - cm CT	80						100						120						140					
	A	B	C	D	E	F	A	B	C	D	E	F	A	B	C	D	E	F	A	B	C	D	E	F
120	C - cm																							
140																								
160																								
180																								
200																								
220																								
240																								
260																								
280																								
300																								

L - cm CT	160						180						200						220					
	A	B	C	D	E	F	A	B	C	D	E	F	A	B	C	D	E	F	A	B	C	D	E	F
120	C - cm																							
140																								
160																								
180																								
200																								
220																								
240																								
260																								
280																								
300																								

L - cm CT	240						260						280											
	A	B	C	D	E	F	A	B	C	D	E	F	A	B	C	D	E	F						
120	C - cm																							
140																								
160																								
180																								
200																								
220																								
240																								
260																								
280																								
300																								

Maggiorazioni - Surcharges - Suppléments - Zuschläge - Suplementos - Dodatkowa opłata

L - cm	80	100	120	140	160	180	200	220	240	260	280
65 - 67											
18 - 25 - 312 - A2 - A3 - A5 - A6 + WOOD											
65 - 67 + WOOD											
18 - 25 - 312 - A2 - A3 - A5 - A6 + SKY											
65 - 67 + SKY											
A267 - A367 - A567 - 3126											
N&D											

FIN = Finitura - Finish - Finition - Fertigung - Acabado - Wykończenie

L = Larghezza sistema (cm) - System width (cm) - Largeur système (cm) - Gesamtbreite (cm) - Ancho sistema (cm) - Szerokość systemu (cm)

CT = Classe tessuto - Fabric category - Catégorie tissu - Gewebegruppe - Categoría tejido - Klasa tkaniny

C = Altezza tessuto (cm) - Fabric height (cm) - Hauteur de la toile (cm) - Stoff Höhe (cm) - Altura tejido (cm) - Wysokość tkaniny (cm)

# ARCADIA - CARENA - ERIS - PERSEO

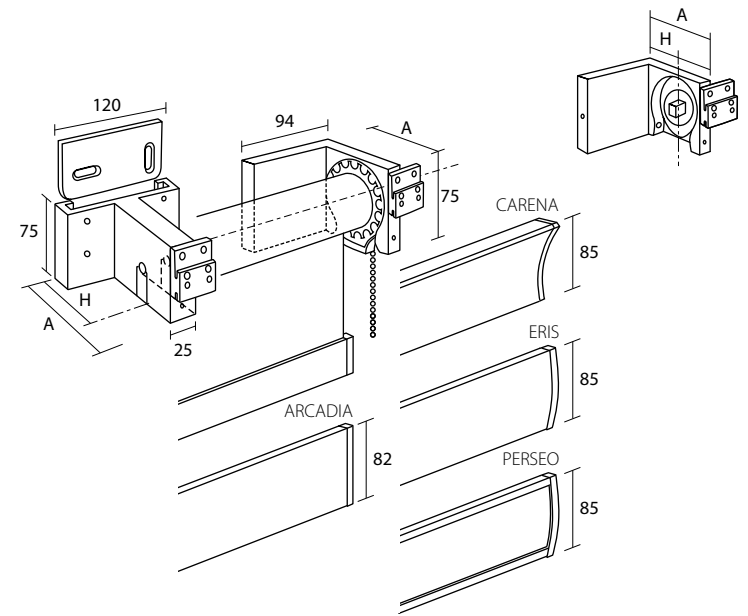
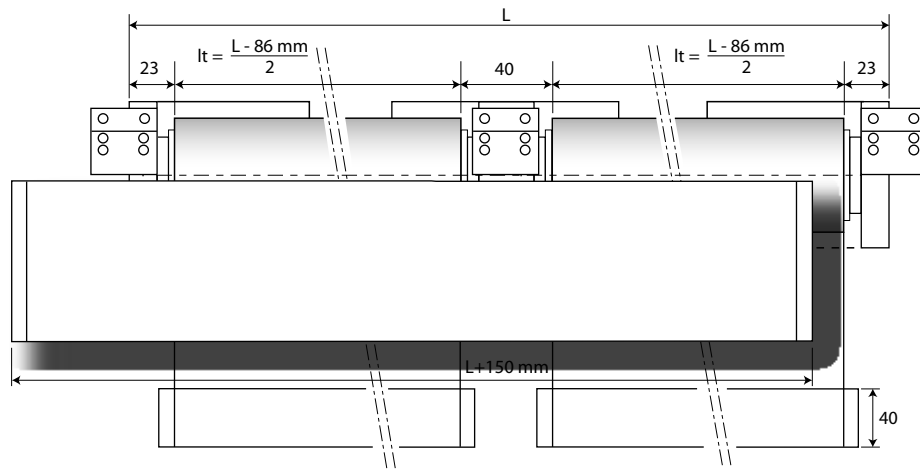

ARCADIA  
Cod. 623B14

Sistema continuo a parete  
Wall consecutive system

CARENA  
Cod. 813B14

Système continu de face  
Wandsystem mit Seite an Seite Stoffen

ERIS  
Cod. 923B14

PERSEO  
Cod. 943B14

Sistema pared continuo  
System ścienny ciągły

Cod.	923614	923664
A - mm	94	144
H - mm	53	103

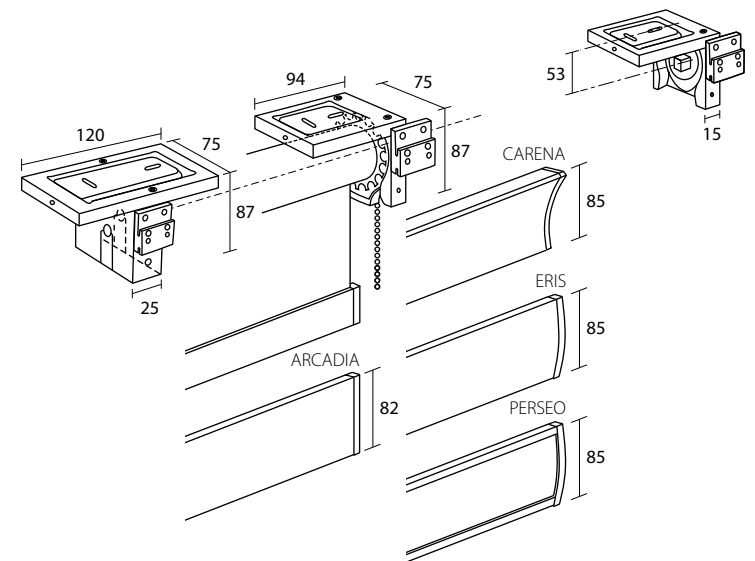
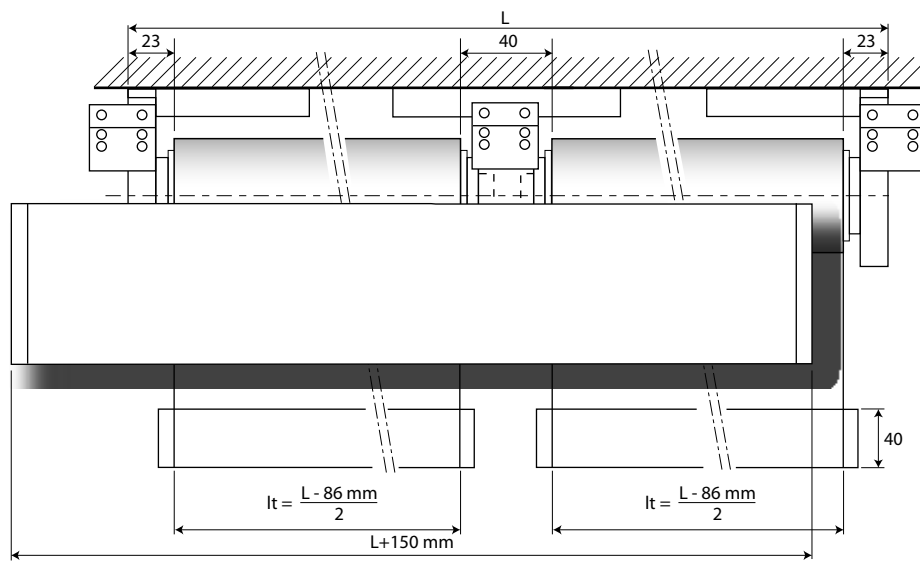

ARCADIA  
Cod. 623W24

Sistema continuo a soffitto  
Ceiling consecutive system

CARENA  
Cod. 813W24

Système continu plafond  
Deckensystem mit Seite an Seite Stoffen

ERIS  
Cod. 923W24

PERSEO  
Cod. 943W24

Sistema continuo techo  
System sufitowy ciągły



18

25

65

67

312

A2

A3

A5

A6

B1

B2

B3

B4

BB

BC

BN

IB

IN

IR

A = Sporgenza supporto - Bracket's projection - Retour support - Träger Abstand - Escuadra de separación - Występwsponnika

H = Distanza parete - Wall distance - Retour du mur - Wand Abstand - Distancia pared - Odległość od ściany

L = Larghezza sistema (cm) - System width (cm) - Largeur système (cm) - Gesamtbreite (cm) - Ancho sistema (cm) - Szerokość systemu (cm)

It = Larghezza singolo tessuto - Fabric width per unit - Largeur chaque toile - Stoff Breite - Ancho de cada tejido - Szerokość pojedynczej tkaniny

FIN 18 - 25 - 312 - A2 - A3 - A5 - A6 - 3122 - A225 - A325 - A525 - A625

Supporti - Brackets - Supports - Träger - Soportes - Wsporniki Cod. 923614 - 923624

L - cm CT	200						240						280						320					
	A	B	C	D	E	F	A	B	C	D	E	F	A	B	C	D	E	F	A	B	C	D	E	F
120	C - cm																							
140																								
160																								
180																								
200																								
220																								
240																								
260																								
280																								
300																								

L - cm CT	360						400						440						480					
	A	B	C	D	E	F	A	B	C	D	E	F	A	B	C	D	E	F	A	B	C	D	E	F
120	C - cm																							
140																								
160																								
180																								
200																								
220																								
240																								
260																								
280																								
300																								

L - cm CT	520						560																	
	A	B	C	D	E	F	A	B	C	D	E	F	A	B	C	D	E	F	A	B	C	D	E	F
120	C - cm																							
140																								
160																								
180																								
200																								
220																								
240																								
260																								
280																								
300																								

Maggiorazioni - Surcharges - Suppléments - Zuschläge - Suplementos - Dodatkowa opłata

L - cm	200	240	280	320	360	400	440	480	520	560
65 - 67										
18 - 25 - 312 - A2 - A3 - A5 - A6 + WOOD										
65 - 67 + WOOD										
18 - 25 - 312 - A2 - A3 - A5 - A6 + SKY										
65 - 67 + SKY										
A267 - A367 - A567 - 3126										
N&D										

FIN = Finitura - Finish - Finition - Fertigung - Acabado - Wykończenie

L = Larghezza sistema (cm) - System width (cm) - Largeur système (cm) - Gesamtbreite (cm) - Ancho sistema (cm) - Szerokość systemu (cm)

CT = Classe tessuto - Fabric category - Catégorie tissu - Gewebegruppe - Categoría tejido - Klasa tkaniny

C = Altezza tessuto (cm) - Fabric height (cm) - Hauteur de la toile (cm) - Stoff Höhe (cm) - Altura tejido (cm) - Wysokość tkaniny (cm)



# ARCADIA - CARENA - ERIS - PERSEO

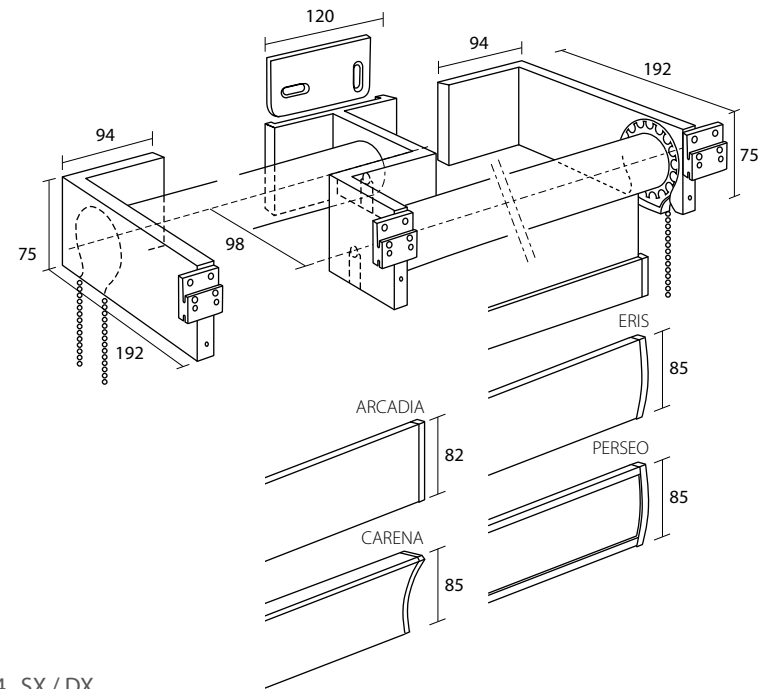
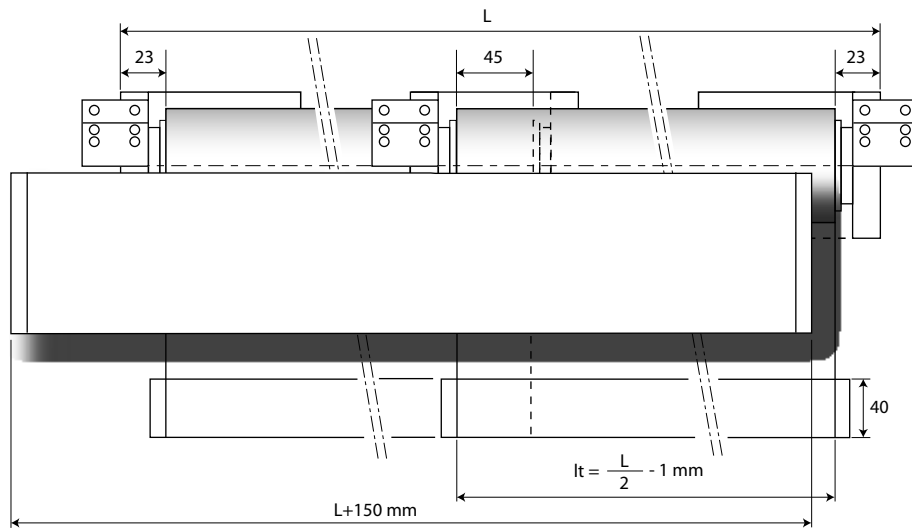
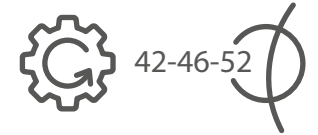

**ARCADIA**  
Cod. 623D34...SX / DX

Sistema a parete slalom 2 teli  
Wall slalom double system

**CARENA**  
Cod. 813D34...SX / DX

Système de face slalom double  
Wandsystem Slalom mit zwei Stoffen Spaltlos

**ERIS**  
Cod. 923D34...SX / DX

**PERSEO**  
Cod. 943D34...SX / DX

Sistema pared slalom 2 tejidos independientes  
System ścienny slalom 2 tkaniny

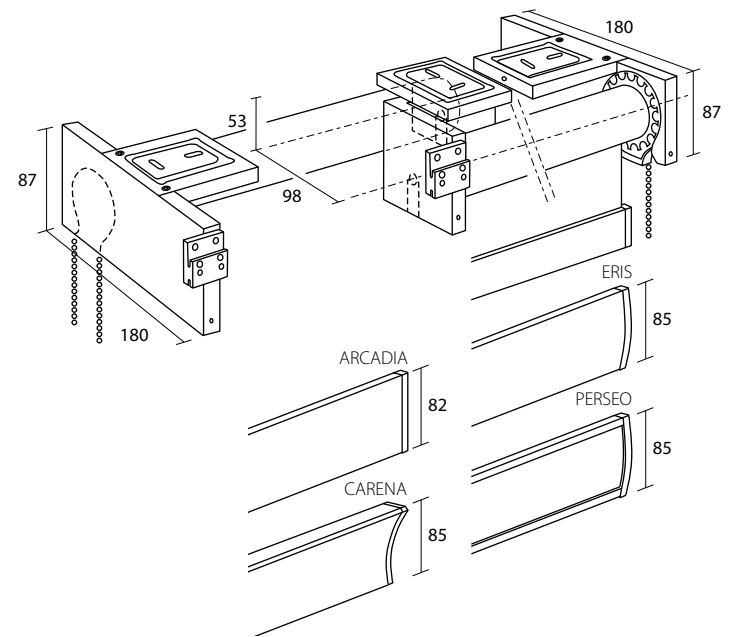
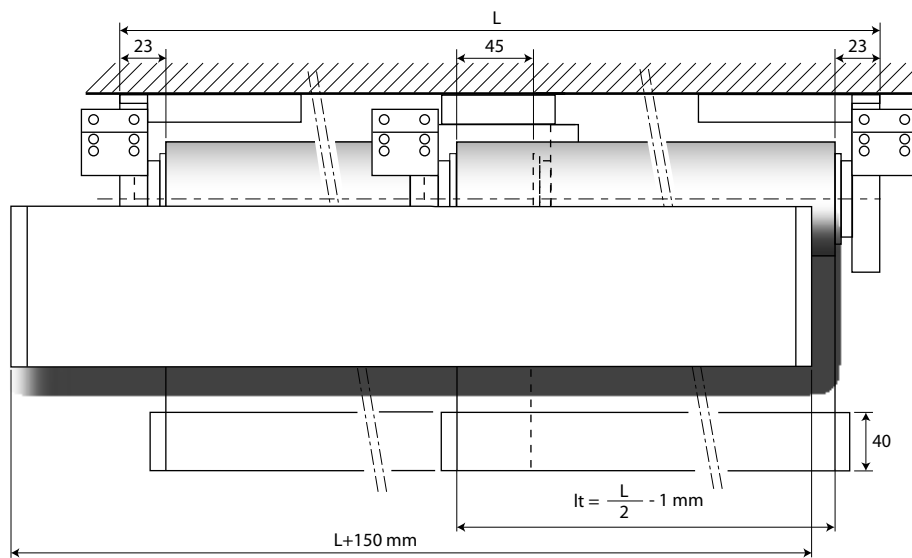

**ARCADIA**  
Cod. 623S44...SX / DX

Sistema a soffitto slalom 2 teli  
Ceiling slalom double system

**CARENA**  
Cod. 813S44...SX / DX

Système plafond slalom double  
Deckensystem Slalom mit zwei Stoffen Spaltlos

**ERIS**  
Cod. 923S44...SX / DX

**PERSEO**  
Cod. 943S44...SX / DX

Sistema techo slalom 2 tejidos independientes  
System sufitowy slalom 2 tkaniny



18 25 65 67 312 A2 A3 A5 A6 B1 B2 B3 B4 BB BC BN IB IN IR

**A** = Sporgenza supporto - Bracket's projection - Retour support - Träger Abstand - Escuadra de separación - Występwsponnika

**H** = Distanza parete - Wall distance - Retour du mur - Wand Abstand - Distancia pared - Odległość od ściany

**L** = Larghezza sistema (cm) - System width (cm) - Largeur système (cm) - Gesamtbreite (cm) - Ancho sistema (cm) - Szerokość systemu (cm)

**lt** = Larghezza singolo tessuto - Fabric width per unit - Largeur chaque toile - Stoff Breite - Ancho de cada tejido - Szerokość pojedynczej tkaniny

FIN 18 - 25 - 312 - A2 - A3 - A5 - A6 - 3122 - A225 - A325 - A525 - A625

L - cm CT	200						240						280						320					
	A	B	C	D	E	F	A	B	C	D	E	F	A	B	C	D	E	F	A	B	C	D	E	F
120	C - cm																							
140																								
160																								
180																								
200																								
220																								
240																								
260																								
280																								
300																								

L - cm CT	360						400						440						480					
	A	B	C	D	E	F	A	B	C	D	E	F	A	B	C	D	E	F	A	B	C	D	E	F
120	C - cm																							
140																								
160																								
180																								
200																								
220																								
240																								
260																								
280																								
300																								

L - cm CT	520						560																	
	A	B	C	D	E	F	A	B	C	D	E	F	A	B	C	D	E	F	A	B	C	D	E	F
120	C - cm																							
140																								
160																								
180																								
200																								
220																								
240																								
260																								
280																								
300																								

Maggiorazioni - Surcharges - Suppléments - Zuschläge - Suplementos - Dodatkowa opłata

L - cm	200	240	280	320	360	400	440	480	520	560
65 - 67										
18 - 25 - 312 - A2 - A3 - A5 - A6 + WOOD										
65 - 67 + WOOD										
18 - 25 - 312 - A2 - A3 - A5 - A6 + SKY										
65 - 67 + SKY										
A267 - A367 - A567 - 3126										
N&D										

FIN = Finitura - Finish - Finition - Fertigung - Acabado - Wykończenie

L = Larghezza sistema (cm) - System width (cm) - Largeur système (cm) - Gesamtbreite (cm) - Ancho sistema (cm) - Szerokość systemu (cm)

CT = Classe tessuto - Fabric category - Catégorie tissu - Gewebegruppe - Categoría tejido - Klasa tkaniny

C = Altezza tessuto (cm) - Fabric height (cm) - Hauteur de la toile (cm) - Stoff Höhe (cm) - Altura tejido (cm) - Wysokość tkaniny (cm)



# ARCADIA - CARENA

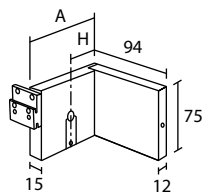

9234--

Lato perno  
Pivot side  
Côté pivot

Träger Achseseite  
Lado pivote  
Strona czopa

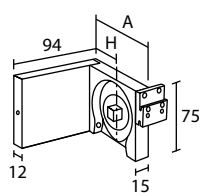

9234--

Lato catena  
Chain side  
Côté chainette

Träger Ketteseite  
Lado cadena Eris  
Strona łańcuszka

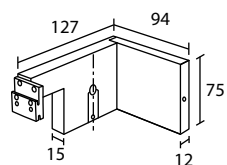

923818

Lato perno Carena  
Pivot side Carena  
Côté pivot Carena  
Träger Achseseite Carena  
Lado pivote Carena  
Strona czopa Carena

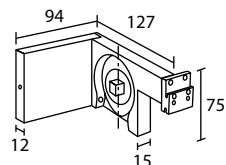

923819

Lato catena Carena  
Chain side Carena  
Côté chainette Carena  
Träger Ketteseite Carena  
Lado cadena Carena  
Strona łańcuszka Carena

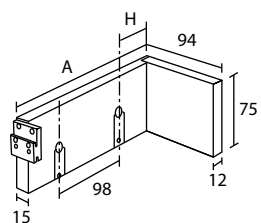

923458 923498

Doppio lato perno  
Double pivot side  
Double côté pivot  
Doppelträger Pchseseite  
Doble lado pivote  
Podwójny strona czopu

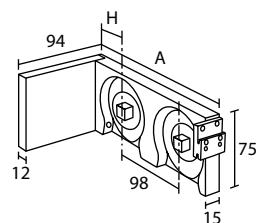

923459 923499

Doppio lato catena  
Double chain side  
Double côté chainette  
Doppelträger Cetteseite  
Doble lado cadena  
Podwójny strona łańcuszka

P = Lato perno - Pivot side - Côté pivot - Achseseite - Lado Pivote - Strona czopa  
C = Lato catena - Chain side - Côté chainette - Ketteseite - Lado cadena - Strona łańcuszka

SISTEMA A PARETE - WALL SYSTEM - SYSTÈME DE FACE - WANDMONTAGE - SISTEMA PARED - SYSTEM ŚCIENNY

Cod.		923418SX / DX	923438SX / DX	923448SX / DX	923478SX / DX
FIN	A - mm	94	144	192	242
	H - mm	53	103	151	201
18 - 25 - 312					
65 - 67					

Cod.		923419SX / DX	923439SX / DX	923449SX / DX	923479SX / DX
FIN	A - mm	94	144	192	242
	H - mm	53	103	151	201
18 - 25 - 312					
65 - 67					

Cod.		923818SX / DX	923819SX / DX
FIN			
18 - 25 - 312			
65 - 67			

Cod.		923458SX / DX	923498SX / DX	923459SX / DX	923499SX / DX
FIN	A - mm	192	242	192	242
	H - mm	53	103	53	103
18 - 25 - 312					
65 - 67					

# ERIS - PERSEO

P = Lato perno - Pivot side - Côté pivot - Achseseite - Lado Pivote - Strona czopa  
 C = Lato catena - Chain side - Côté chaînette - Ketteseite - Lado cadena - Strona łańcuszka

SISTEMA A PARETE - WALL SYSTEM - SYSTÈME DE FACE - WANDMONTAGE - SISTEMA PARED - SYSTEM ŚCIENNY

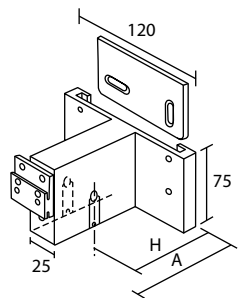

923614 923664  
 Intermedio P/P  
 Middle P/P  
 Intermédiaire P/P  
 Mittelträger P/P  
 Intermedio P/P  
 Środkowy P/P

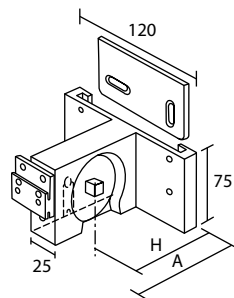

923615 923665  
 Intermedio P/C  
 Middle P/C  
 Intermédiaire P/C  
 Mittelträger P/C  
 Intermedio P/C  
 Środkowy P/C

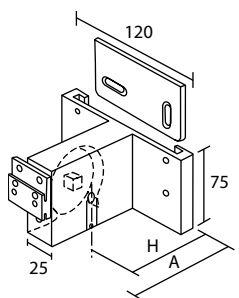

923616 923666  
 Intermedio C/P  
 Middle C/P  
 Intermédiaire C/P  
 Mittelträger C/P  
 Intermedio C/P  
 Środkowy C/P

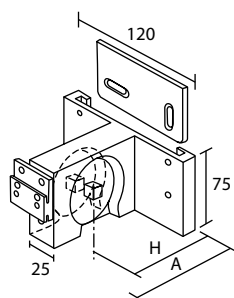

923617 923667  
 Intermedio C/C  
 Middle C/C  
 Intermédiaire C/C  
 Mittelträger C/C  
 Intermedio C/C  
 Środkowy C/C

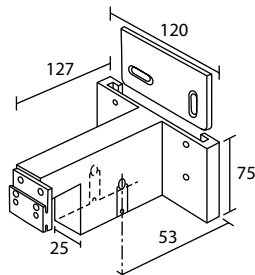

923654  
 Intermedio P/P Carena  
 Middle P/P Carena  
 Intermédiaire P/P Carena

Mittelträger P/P Carena  
 Intermedio P/P Carena  
 Środkowy P/P Carena

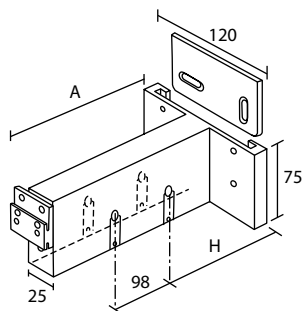

923634 923744  
 Intermedio doppio  
 Middle double  
 Intèrmediaire double  
 Doppel-mittelträger  
 Intermedio doble  
 Środkowy podwójny

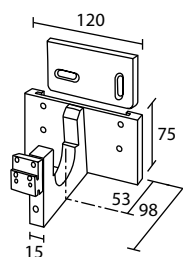

923609  
 Singolo passante  
 Bypassing  
 Single passant  
 Einzelträger vorübergehend  
 Intermedio pasante  
 Pojedynczy przelotowy

Cod.		923614	923664	923615	923665
FIN	A - mm	94	144	94	144
	H - mm	53	103	53	103
18 - 25 - 312 65 - 67					

Cod.		923616	923666	923617	923667
FIN	A - mm	94	144	94	144
	H - mm	53	103	53	103
18 - 25 - 312 65 - 67					

Cod.		923654
FIN		
18 - 25 - 312 65 - 67		

Cod.		923634	923744	923609
FIN	A - mm	192	242	
	H - mm	53	103	
18 - 25 - 312 65 - 67				

# ARCADIA - CARENA

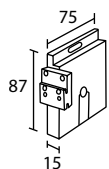

923698

Rosetta P  
Recess bracket P  
Naissance murale P  
Wandlager P  
Soporte lateral P  
Podkładka okrągła P

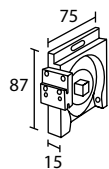

923699

Rosetta C  
Recess bracket C  
Naissance murale C  
Wandlager C  
Soporte lateral C  
Podkładka okrągła C

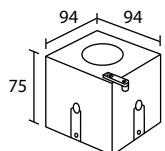

923674

Angolare interno P/P  
Inner corner P/P  
Angle interne P/P  
Innen-eckenträger P/P  
Angulo interno P/P  
Kątownik wewnętrzny P/P

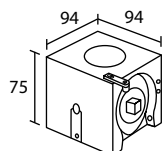

923675

Angolare interno P/C  
Inner corner P/C  
Angle interne P/C  
Innen-eckenträger P/C  
Angulo interno P/C  
Kątownik wewnętrzny P/C

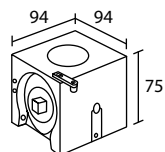

923676

Angolare interno C/P  
Inner corner C/P  
Angle interne C/P

Innen-eckenträger C/P  
Angulo interno C/P  
Kątownik wewnętrzny C/P

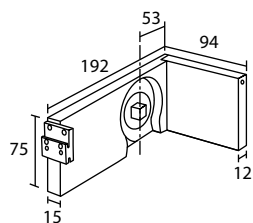

923579

Jumbo C  
Jumbo C  
Jumbo C  
Jumboträger C  
Jumbo C  
Jumbo C

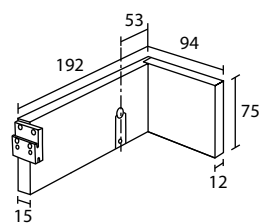

923578

Jumbo P  
Jumbo P  
Jumbo P  
Jumboträger P  
Jumbo P  
Jumbo P

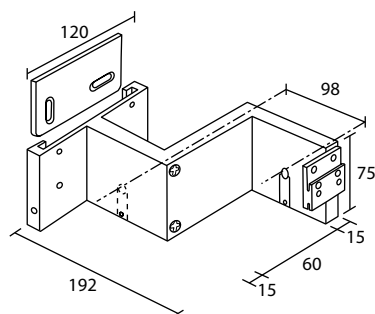

923534

Slalom P/P  
Slalom P/P  
Slalom P/P

Slalomträger P/P  
Slalom P/P  
Slalom P/P

P = Lato perno - Pivot side - Côté pivot - Achseseite - Lado Pivote - Strona czopa  
C = Lato catena - Chain side - Côté chainette - Ketteseite - Lado cadena - Strona łańcuszka

SISTEMA A PARETE - WALL SYSTEM - SYSTÈME DE FACE - WANDMONTAGE - SISTEMA PARED - SYSTEM ŚCIENNY

<b>Cod.</b>	<b>923698SX / DX</b>	<b>923699SX / DX</b>
<b>FIN</b>		
<b>18 - 25 - 312</b>		
<b>65 - 67</b>		

<b>Cod.</b>	<b>923674</b>	<b>923675</b>
<b>FIN</b>		
<b>18 - 25 - 312</b>		
<b>65 - 67</b>		

<b>Cod.</b>	<b>923676</b>
<b>FIN</b>	
<b>18 - 25 - 312</b>	
<b>65 - 67</b>	

<b>Cod.</b>	<b>923579SX / DX</b>	<b>923578SX / DX</b>
<b>FIN</b>		
<b>18 - 25 - 312</b>		
<b>65 - 67</b>		

<b>Cod.</b>	<b>923534SX / DX</b>
<b>FIN</b>	
<b>18 - 25 - 312</b>	
<b>65 - 67</b>	

# ERIS - PERSEO

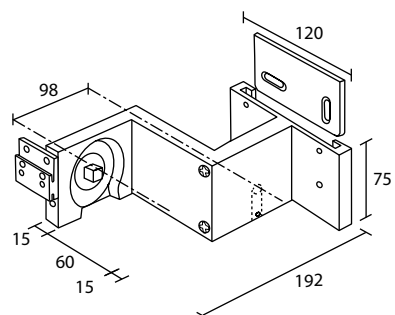

923535

Slalom P/C  
Slalom P/C  
Slalom P/C

Slalomträger P/C  
Slalom P/C  
Slalom P/C

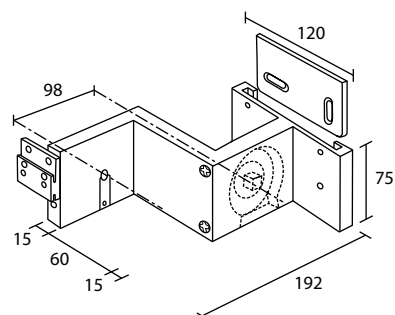

923536

Slalom C/P  
Slalom C/P  
Slalom C/P

Slalomträger C/P  
Slalom C/P  
Slalom C/P

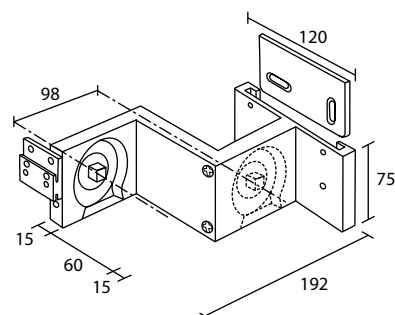

923537

Slalom C/C  
Slalom C/C  
Slalom C/C

Slalomträger C/C  
Slalom C/C  
Slalom C/C

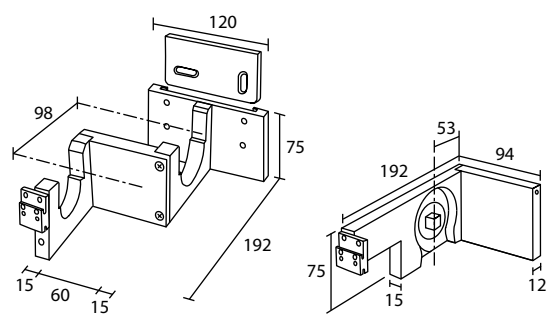

923559

Slalom passante  
Slalom bypassing  
Slalom passant  
Slalomträger vorübergehend  
Slalom pasante  
Slalom przelotowy

923759

C + pannello  
C with panel glide  
C + panneau  
Flächen-vorhanganlage C  
C + panel  
C + panel

P = Lato perno - Pivot side - Côté pivot - Achseseite - Lado Pivote - Strona czopa  
C = Lato catena - Chain side - Côté chainette - Ketteseite - Lado cadena - Strona łańcuszka

SISTEMA A PARETE - WALL SYSTEM - SYSTÈME DE FACE - WANDMONTAGE - SISTEMA PARED - SYSTEM ŚCIENNY

**Cod. 923535SX / DX**

**FIN**  
**18 - 25 - 312**  
**65 - 67**

**Cod. 923536SX / DX**

**FIN**  
**18 - 25 - 312**  
**65 - 67**

**Cod. 923537SX / DX**

**FIN**  
**18 - 25 - 312**  
**65 - 67**

**Cod. 923559SX / DX**

**FIN**  
**18 - 25 - 312**  
**65 - 67**

**923759SX / DX**



# ARCADIA - CARENA

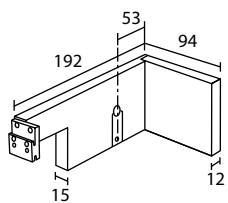

923758

P + pannello  
P with panel glide  
P + panneau

Paneelwagen P  
P + panel  
P + panel

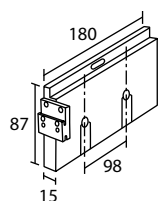

923718

Rosetta doppia P  
Double recess bracket P  
Naissance double P  
Doppelwandlager P  
Soporte lateral doble P  
Podkładka okrągła podwójna P

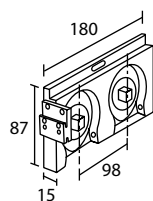

923719

Rosetta doppia C  
Double recess bracket C  
Naissance double C  
Doppelwandlager C  
Soporte lateral doble C  
Podkładka okrągła podwójna C

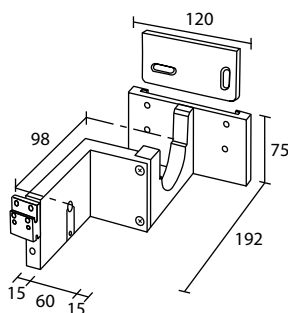

923774

Slalom passante P  
Bypassing slalom P  
Passant slalom P  
Slalomträger vorübergehend P  
Slalom pasante P  
Slalom przelotowy P

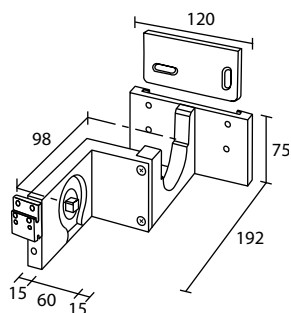

923776

Slalom passante C  
Bypassing slalom C  
Passant slalom C  
Slalomträger vorübergehend C  
Slalom pasante C  
Slalom podwójny C

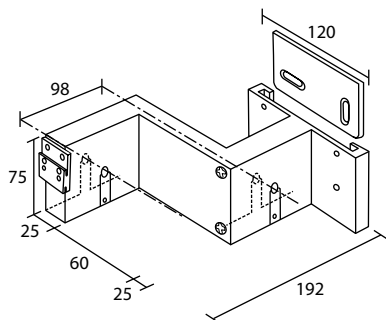

923584

Slalom doppio  
Double slalom  
Slalom double

Doppel-slalomträger  
Slalom doble  
Slalom podwójny

P = Lato perno - Pivot side - Côté pivot - Achseseite - Lado Pivote - Strona czopa  
C = Lato catena - Chain side - Côté chaînette - Ketteseite - Lado cadena - Strona łańcuszka

SISTEMA A PARETE - WALL SYSTEM - SYSTÈME DE FACE - WANDMONTAGE - SISTEMA PARED - SYSTEM ŚCIENNY

<b>Cod.</b>	<b>923758SX / DX</b>	
<b>FIN</b>		
<b>18 - 25 - 312</b>		
<b>65 - 67</b>		

<b>Cod.</b>	<b>923718SX / DX</b>	<b>923719SX / DX</b>
<b>FIN</b>		
<b>18 - 25 - 312</b>		
<b>65 - 67</b>		

<b>Cod.</b>	<b>923774SX / DX</b>	<b>923776SX / DX</b>
<b>FIN</b>		
<b>18 - 25 - 312</b>		
<b>65 - 67</b>		

<b>Cod.</b>	<b>923584SX / DX</b>
<b>FIN</b>	
<b>18 - 25 - 312</b>	
<b>65 - 67</b>	

# ERIS - PERSEO

P = Lato perno - Pivot side - Côté pivot - Achseseite - Lado Pivote - Strona czopa  
 C = Lato catena - Chain side - Côté chainette - Ketteseite - Lado cadena - Strona łańcuszka

SISTEMA A SOFFITTO - CEILING SYSTEM - SYSTÈME PLAFOND - DECKENMONTAGE - SISTEMATECHO - SYSTEM SUFITOWY

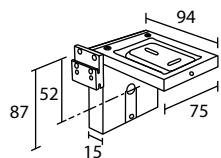

923428  
 Lato perno  
 Pivot side  
 Côté pivot  
 Träger Achseseite  
 Lado pivote  
 Strona czopa

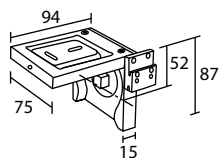

923429  
 Lato catena  
 Chain side  
 Côté chainette  
 Träger Ketteseite  
 Lado cadena  
 Strona łańcuszka

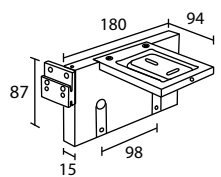

923468  
 Doppio P  
 Double P  
 Double P  
 Doppelträger P  
 Doble P  
 Podwójny P

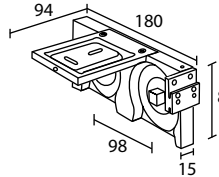

923469  
 Doppio C  
 Double C  
 Double C  
 Doppelträger C  
 Doble C  
 Podwójny C

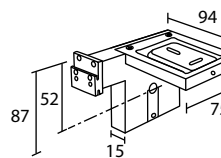

923828  
 Lato perno Carena  
 Pivot side Carena  
 Côté pivot Carena  
 Träger Achseseite Carena  
 Lado pivote Carena  
 Strona czopa Carena

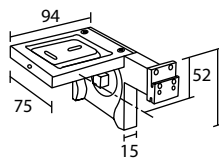

923839  
 Lato catena Carena  
 Chain side Carena  
 Côté chainette Carena  
 Träger Ketteseite Carena  
 Lado cadena Carena  
 Strona łańcuszka Carena

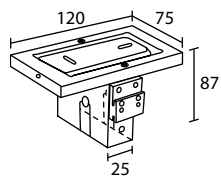

923624  
 Intermedio P/P  
 Middle P/P  
 Intermédiaire P/P  
 Mittelträger P/P  
 Intermedio P/P  
 Środkowy P/P

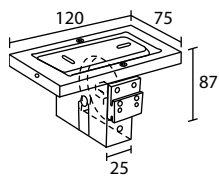

923625  
 Intermedio P/C  
 Middle P/C  
 Intermédiaire P/C  
 Mittelträger P/C  
 Intermedio P/C  
 Środkowy P/C

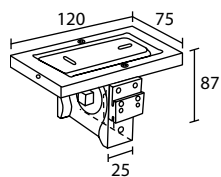

923626  
 Intermedio C/P  
 Middle C/P  
 Intermédiaire C/P  
 Mittelträger C/P  
 Intermedio C/P  
 Środkowy C/P

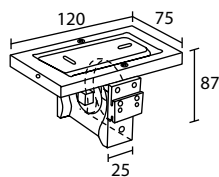

923627  
 Intermedio C/C  
 Middle C/C  
 Intermédiaire C/C  
 Mittelträger C/C  
 Intermedio C/C  
 Środkowy C/C

<b>Cod.</b>	<b>923428SX / DX</b>	<b>923429SX / DX</b>
<b>FIN</b>		
<b>18 - 25 - 312</b>		
<b>65 - 67</b>		

<b>Cod.</b>	<b>923468SX / DX</b>	<b>923469SX / DX</b>
<b>FIN</b>		
<b>18 - 25 - 312</b>		
<b>65 - 67</b>		

<b>Cod.</b>	<b>923828SX / DX</b>	<b>923829SX / DX</b>
<b>FIN</b>		
<b>18 - 25 - 312</b>		
<b>65 - 67</b>		

<b>Cod.</b>	<b>923624</b>	<b>923625</b>
<b>FIN</b>		
<b>18 - 25 - 312</b>		
<b>65 - 67</b>		

<b>Cod.</b>	<b>923626</b>	<b>923627</b>
<b>FIN</b>		
<b>18 - 25 - 312</b>		
<b>65 - 67</b>		

# ARCADIA - CARENA

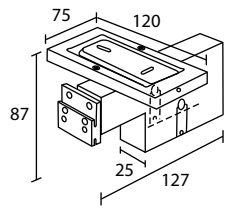

923694

Intermedio P/P Carena  
Middle P/P Carena  
Intermédiaire P/P Carena  
Mittelträger P/P Carena  
Intermedio P/P Carena  
Środkowy P/P Carena

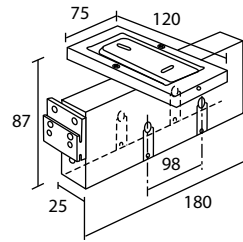

923644

Intermedio doppio P/P  
Middle double P/P  
Intèrmediaire double P/P  
Doppel-mittelträger P/P  
Intermedio doble P/P  
Środkowy podwójny P/P

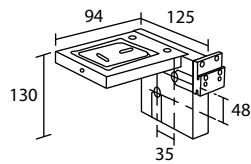

383468

Doppio sfalsato a soffitto P  
More vertically located ceiling double P  
Double décalé à plafond P  
Doppelter Deckenversatz P  
Doble a techo no alineado P  
Podwójne mocowanie sufitowe P

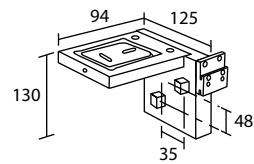

383469

Doppio sfalsato a soffitto C  
More vertically located ceiling double C  
Double décalé à plafond C  
Doppelter Deckenversatz C  
Doble a techo no alineado C  
Podwójne mocowanie sufitowe C

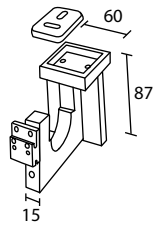

923659

Intermedio passante  
Middle bypassing  
Intèrmediaire passant  
Mittelträger vorübergehend  
Intermedio pasante  
Środkowy przelotowy

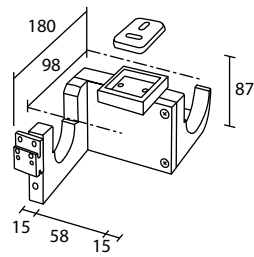

923569

Slalom passante  
Slalom bypassing  
Slalom passant  
Slalomträger vorübergehend  
Slalom pasante  
Slalom przelotowy

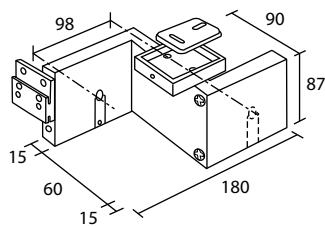

923544

Slalom P/P  
Slalom P/P  
Slalom P/P

Slalomträger P/P  
Slalom P/P  
Slalom P/P

P = Lato perno - Pivot side - Côté pivot - Achseseite - Lado Pivote - Strona czopa  
C = Lato catena - Chain side - Côté chainette - Ketteseite - Lado cadena - Strona łańcuszka

SISTEMA A SOFFITTO - CEILING SYSTEM - SYSTÈME PLAFOND - DECKENMONTAGE - SISTEMATECHO - SYSTEM SUFITOWY

<b>Cod.</b>	<b>923694</b>	<b>923644</b>
<b>FIN</b>		
<b>18 - 25 - 312</b>		
<b>65 - 67</b>		

<b>Cod.</b>	<b>383468</b>	<b>383469</b>
<b>FIN</b>		
<b>18 - 25 - 312</b>		
<b>65 - 67</b>		

<b>Cod.</b>	<b>923659</b>	<b>923569SX / DX</b>
<b>FIN</b>		
<b>18 - 25 - 312</b>		
<b>65 - 67</b>		

<b>Cod.</b>	<b>923544SX / DX</b>
<b>FIN</b>	
<b>18 - 25 - 312</b>	
<b>65 - 67</b>	

# ERIS - PERSEO

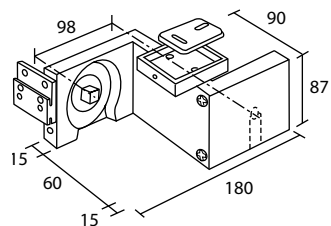

923545

Slalom P/C  
Slalom P/C  
Slalom P/C

Slalomträger P/C  
Slalom P/C  
Slalom P/C

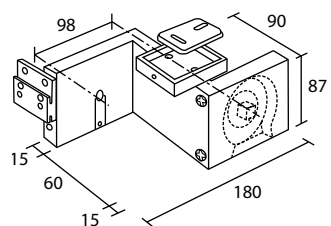

923546

Slalom C/P  
Slalom C/P  
Slalom C/P

Slalomträger C/P  
Slalom C/P  
Slalom C/P

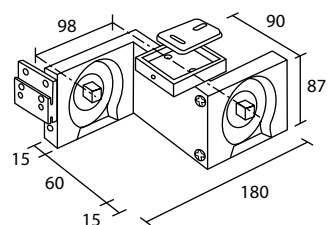

923547

Slalom C/C  
Slalom C/C  
Slalom C/C

Slalomträger C/C  
Slalom C/C  
Slalom C/C

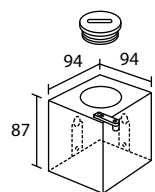

923724

Angolare esterno P/P  
Outer corner P/P  
Angle externe P/P  
Aussen-eckenträger P/P  
Ângulo externo P/P  
Kątownik zewnętrzny P/P

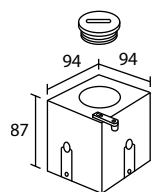

923684

Angolare interno P/P  
Inner corner P/P  
Angle interne P/P  
Innen-eckenträger P/P  
Ângulo interno P/P  
Kątownik wewnętrzny P/P

P = Lato perno - Pivot side - Côté pivot - Achseseite - Lado Pivote - Strona czopa  
C = Lato catena - Chain side - Côté chainette - Ketteseite - Lado cadena - Strona łańcuszka

SISTEMA A SOFFITTO - CEILING SYSTEM - SYSTÈME PLAFOND - DECKENMONTAGE - SISTEMATECHO - SYSTEM SUFITOWY

**Cod. 923545SX / DX**

**FIN**  
**18 - 25 - 312**  
**65 - 67**

**Cod. 923546SX / DX**

**FIN**  
**18 - 25 - 312**  
**65 - 67**

**Cod. 923547SX / DX**

**FIN**  
**18 - 25 - 312**  
**65 - 67**

**Cod. 923724**

**FIN**  
**18 - 25 - 312**  
**65 - 67**

**923684**



# ARCADIA - CARENA

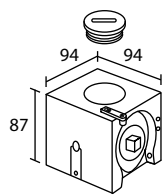

923685

Angolare interno P/C  
Inner corner P/C  
Angle interne P/C

Innen-eckenträger P/C  
Angulo interno P/C  
Kątownik wewnętrzny P/C

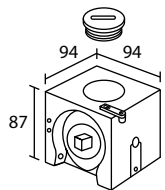

923686

Angolare interno C/P  
Inner corner C/P  
Angle interne C/P

Innen-eckenträger C/P  
Angulo interno C/P  
Kątownik wewnętrzny C/P

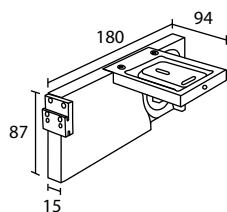

923529

Jumbo C  
Jumbo C  
Jumbo C

Jumboträger C  
Jumbo C  
Jumbo C

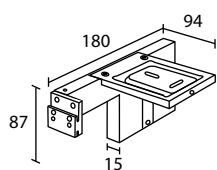

923768

P + pannelo  
P with panel glide  
P + panneau  
Panneelwagen P  
P + panel  
P + panel

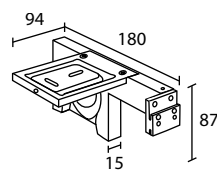

923769

C + pannelo  
C with panel glide  
C + panneau  
Flächen-vorhanganlage C  
C + panel  
C + panel

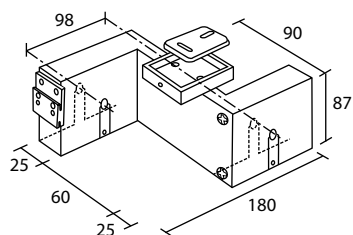

923594

Slalom doppio  
Double slalom  
Slalom double

Doppel-slalomträger  
Slalom doble  
Slalom podwójny

P = Lato perno - Pivot side - Côté pivot - Achseseite - Lado Pivote - Strona czopa  
C = Lato catena - Chain side - Côté chaînette - Ketteseite - Lado cadena - Strona łańcuszka

SISTEMA A SOFFITTO - CEILING SYSTEM - SYSTÈME PLAFOND - DECKENMONTAGE - SISTEMATECHO - SYSTEM SUFITOWY

<b>Cod.</b>	<b>923685</b>
<b>FIN</b>	
<b>18 - 25 - 312</b>	
<b>65 - 67</b>	

<b>Cod.</b>	<b>923686</b>
<b>FIN</b>	
<b>18 - 25 - 312</b>	
<b>65 - 67</b>	

<b>Cod.</b>	<b>923529SX / DX</b>
<b>FIN</b>	
<b>18 - 25 - 312</b>	
<b>65 - 67</b>	

<b>Cod.</b>	<b>923768SX / DX</b>	<b>923769SX / DX</b>
<b>FIN</b>		
<b>18 - 25 - 312</b>		
<b>65 - 67</b>		

<b>Cod.</b>	<b>923594SX / DX</b>
<b>FIN</b>	
<b>18 - 25 - 312</b>	
<b>65 - 67</b>	

# ERIS - PERSEO

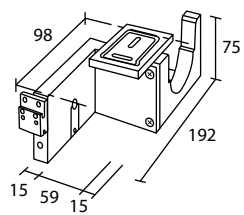

923784

Slalom passante P  
Bypassing slalom P  
Passant slalom P  
Slalomträger vorübergehend P  
Slalom pasante P  
Slalom przelotowy P

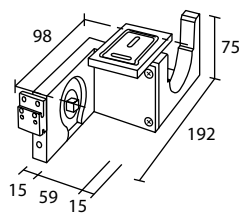

923786

Slalom passante C  
Bypassing slalom C  
Passant slalom C  
Slalomträger vorübergehend C  
Slalom pasante C  
Slalom przelotowy C

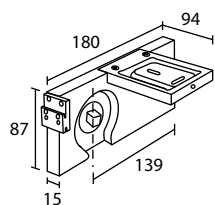

923519

Jumbo C  
Jumbo C  
Jumbo C  
Jumboträger C  
Jumbo C  
Jumbo C

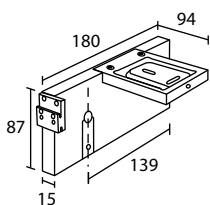

923528

Jumbo P  
Jumbo P  
Jumbo P  
Jumboträger P  
Jumbo P  
Jumbo P

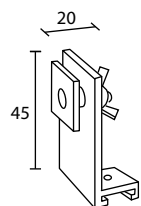

163297

Aggancio binario Carena  
Tracks' hanger Carena  
Accroche pour rail Carena

Schiene Koppelung Carena  
Enganche riel Carena  
Haczyk toru Carena

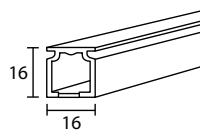

163200

Profilo  
Profile  
Profil  
Profil  
Perfil  
Profil

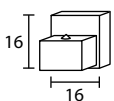

163045

Tappo  
Endcap  
Bouchon  
Endkappe  
Tapón  
Zatyczka

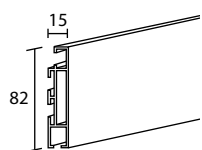

853300

Profilo frontale Arcadia  
Frontal profile Arcadia  
Profil frontal Arcadia  
Blende Arcadia  
Perfil frontal Arcadia  
Profil przedni Arcadia



853311

Tappo Arcadia  
End cap Arcadia  
Bouchon Arcadia  
Endkappe Arcadia  
Tapón Arcadia  
Zatyczka Arcadia

P = Lato perno - Pivot side - Côté pivot - Achseseite - Lado Pivote - Strona czopa

C = Lato catena - Chain side - Côté chainette - Ketteseite - Lado cadena - Strona łańcuszka

SISTEMA A SOFFITTO - CEILING SYSTEM - SYSTÈME PLAFOND - DECKENMONTAGE - SISTEMATECHO - SYSTEM SUFITOWY

<b>Cod.</b>	<b>923784SX / DX</b>	<b>923786SX / DX</b>
<b>FIN</b>		
<b>18 - 25 - 312</b>		
<b>65 - 67</b>		

<b>Cod.</b>	<b>923519SX / DX</b>	<b>923528SX / DX</b>
<b>FIN</b>		
<b>18 - 25 - 312</b>		
<b>65 - 67</b>		

COMPONENTI - COMPONENTS - COMPOSANTS - ZUBEHÖR - COMPONENTES - CZĘŚCI

<b>Cod.</b>	<b>163297</b>
<b>FIN</b>	
<b>18 - 25 - 312</b>	
<b>A2 - A3 - A5 - A6</b>	

<b>Cod.</b>	<b>163200</b>	<b>163045</b>
<b>FIN</b>	<b>L - mt</b>	<b>1</b>
<b>18 - 25 - 312</b>		
<b>65 - 67</b>		
<b>A2 - A3 - A5 - A6</b>		

<b>Cod.</b>	<b>853300</b>	<b>853311</b>
<b>FIN</b>	<b>L - mt</b>	<b>1</b>
<b>18 - 25 - 312</b>		
<b>65 - 67</b>		
<b>A2 - A3 - A5 - A6</b>		

# ARCADIA - CARENA

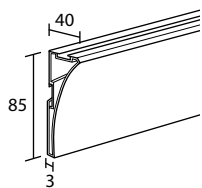

813200

Profilo frontale Carena  
Frontal profile Carena  
Profil frontal Carena  
Blende Carena  
Perfil frontal Carena  
Profil przedni Carena

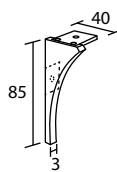

813111 813111CX

Tappo Carena  
End cap Carena  
Bouchon Carena  
Endkappe Carena  
Tapón Carena  
Zatyczka Carena

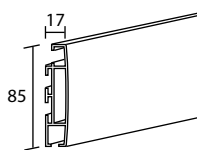

853200

Profilo frontale Eris  
Frontal profile Eris  
Profil frontal Eris  
Blende Eris  
Perfil frontal Eris  
Profil przedni Eris



853111

Tappo Eris  
End cap Eris  
Bouchon Eris  
Endkappe Eris  
Tapón Eris  
Zatyczka Eris

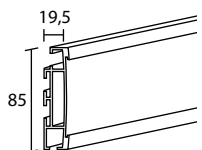

853210

Profilo frontale Perseo  
Frontal profile Perseo  
Profil frontal Perseo

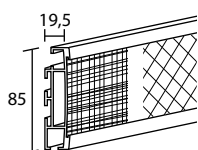

853210

Blende Perseo  
Perfil frontal Perseo  
Profil przedni Perseo

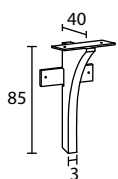

813111CX

Tappo giunzione Carena  
Joiner end cap Carena  
Bouchon jonction Carena  
Endkappe Für Verbindungsstück Carena  
Tapón empalme Carena  
Korek do laczniaka Carena

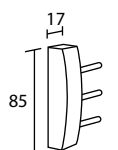

853111SD 853111SS

Tappo modificato  
Modified end cap  
Bouchon modifié  
Veränderte Endkappe  
Tapón modificado  
Zmodyfikowane zakończenie

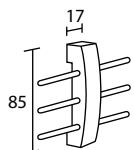

853111CX

Tappo giunzione  
Joiner end cap  
Bouchon jonction  
Endkappe Für Verbindungsstück  
Tapón empalme  
Korek do laczniaka

P = Lato perno - Pivot - Côté pivot - Achseseite - Lado Pivote - Strona czopa  
C = Lato catena - Chain side - Côté chainette - Ketteseite - Lado cadena - Strona łańcuszka

COMPONENTI - COMPONENTS - COMPOSANTS - ZUBEHÖR - COMPONENTES - CZĘŚCI

<b>Cod.</b>		<b>813200</b>	<b>813111SX / DX</b>
<b>FIN</b>	<b>L - mt</b>	<b>1</b>	
<b>18 - 25 - 312</b>			
<b>A2 - A3 - A5 - A6</b>			
<b>65 - 67</b>			

<b>Cod.</b>		<b>853200</b>	<b>853111SX / DX</b>
<b>FIN</b>	<b>L - mt</b>	<b>1</b>	
<b>18 - 25 - 312</b>			
<b>65 - 67</b>			

<b>Cod.</b>		<b>853210</b>	
<b>FIN</b>	<b>L - mt</b>	<b>1</b>	
<b>25 - 312</b>			
<b>65 - 67</b>			
<b>18 - 25 - 312 + WOOD</b>			
<b>65 - 67 + WOOD</b>			
<b>18 - 25 - 312 + SKY</b>			
<b>65 - 67 + SKY</b>			

<b>Cod.</b>		<b>813111CX</b>	
<b>FIN</b>			
<b>18 - 25 - 312</b>			
<b>67</b>			
<b>A2 - A3 - A5 - A6</b>			

<b>Cod.</b>	<b>853111SD (SX)</b>	<b>853111SS (DX)</b>	<b>853111CX</b>
<b>FIN</b>			
<b>18 - 25 - 312</b>			
<b>65 - 67</b>			

# ERIS - PERSEO

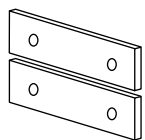

563087  
Giunzione  
Junction  
Jonction  
Verbinder  
Enchufe  
Łącznik

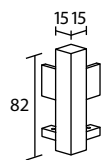

823312  
Giunzione ad angolo Arcadia  
Angle junction Arcadia  
Jonction à angle Arcadia  
Ecke Verbinder Arcadia  
Ángulo Arcadia  
Łącznik kątowy Arcadia

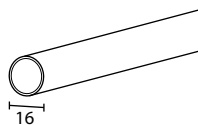

164100  
Peso  
Weight bar  
Barre de lestage  
Beschwerungsprofil  
Perfil contrapeso  
Obciążnik

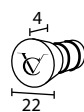

163055  
Tappo per peso  
Endcap for weight bar  
Bouchon pour barre de lestage  
Endkappe Für Beschwerungsprofil  
Tapón para contrapeso  
Zaślepka obciążnika

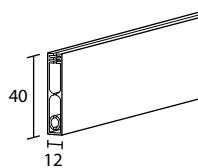

403120  
Peso  
Weight bar  
Barre de lestage  
Beschwerungsprofil  
Perfil contrapeso  
Obciążnik

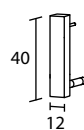

403125  
Tappo per peso  
Endcap for weight bar  
Bouchon pour barre de lestage  
Endkappe Für Beschwerungsprofil  
Tapón para contrapeso  
Zaślepka obciążnika

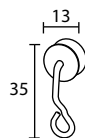

524056  
Scorrevole  
Runner  
Glisseur



1000  
Gleiter  
Corredera  
Ślizgacz



1001

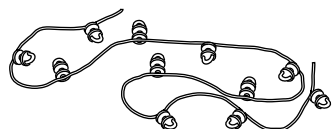

1000--  
Scorrevoli  
Runners  
Glisseurs

Gleiter  
Correderas  
Ślizgacze

P = Lato perno - Pivot side - Côté pivot - Achseseite - Lado Pivote - Strona czopa  
C = Lato catena - Chain side - Côté chainette - Ketteseite - Lado cadena - Strona łańcuszka

COMPONENTI - COMPONENTS - COMPOSANTS - ZUBEHÖR - COMPONENTES - CZĘŚCI

<b>Cod.</b>	<b>563087</b>	<b>823312SX / D</b>
<b>FIN</b>		
<b>18 - 25 - 312</b>		
<b>67</b>		
<b>A2 - A3 - A5 - A6</b>		

<b>Cod.</b>	<b>164100</b>	<b>163055</b>
<b>FIN</b>	<b>l - mt</b>	<b>1</b>
<b>18 - 25 - 312</b>		
<b>67</b>		

<b>Cod.</b>	<b>403120</b>	<b>403125</b>
<b>FIN</b>	<b>l - mt</b>	<b>1</b>
<b>18 - 25 - 65 - 312</b>		
<b>67</b>		

<b>Cod.</b>	<b>524056</b>	<b>1000</b>	<b>1001</b>
<b>FIN</b>			

<b>Cod.</b>	<b>1000P6*</b>	<b>1000P8**</b>
<b>FIN</b>		
<b>Euro/mt</b>		

\* Scorrevoli passo 60 mm - Runners each 60 mm - Glisseurs tous les 60 mm - Gleiter je 60 mm - Correderas cada 60 mm - Ślizgacze co 60 mm  
\*\* Scorrevoli passo 80 mm - Runners each 80 mm - Glisseurs tous les 80 mm - Gleiter je 80 mm - Correderas cada 80 mm - Ślizgacze co 80 mm