

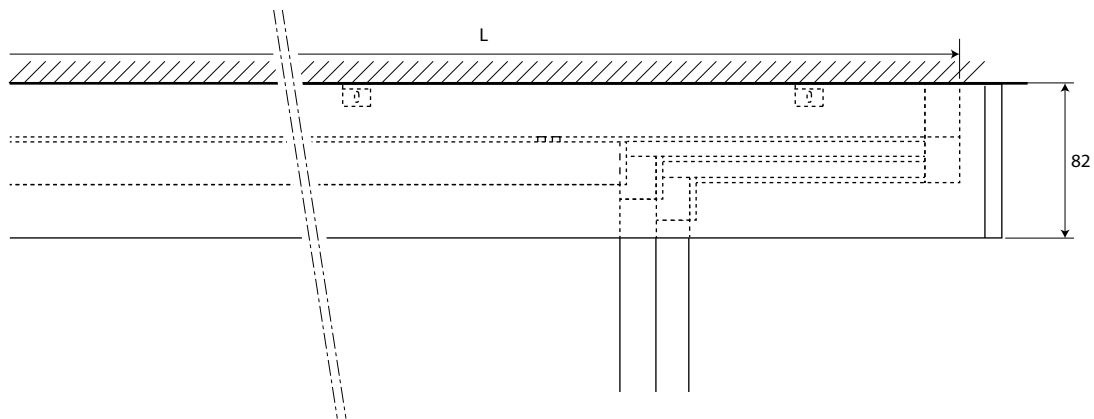



INDUS



Cod. 382T99

Sistema a soffitto - 3 vie
 Ceiling system - 3 ways
 Système plafond - 3 voies
 Deckenmontage - 3läufig
 Sistema techo - 3 vías
 System sufitowy - 3 biegi

Cod. 482T99

Sistema a soffitto - 4 vie
 Ceiling system - 4 ways
 Système plafond - 4 voies
 Deckenmontage - 4läufig
 Sistema techo - 4 vías
 System sufitowy - 4 biegi

Cod. 582T99

Sistema a soffitto - 5 vie
 Ceiling system - 5 ways
 Système plafond - 5 voies
 Deckenmontage - 5läufig
 Sistema techo - 5 vías
 System sufitowy - 5 biegi

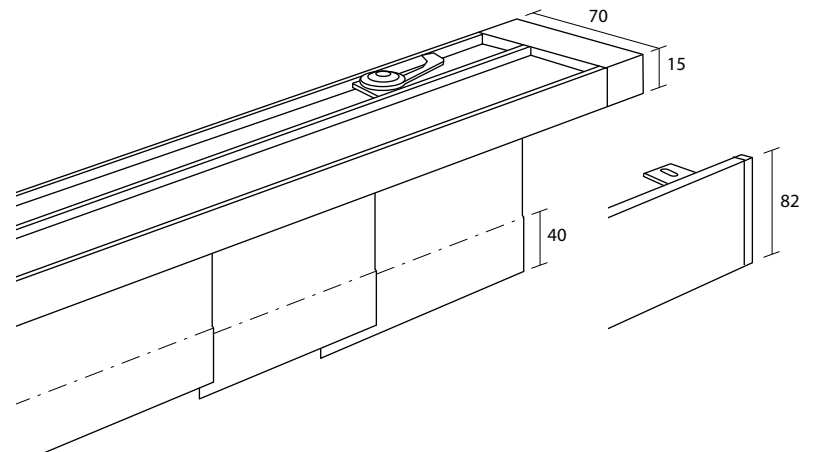

86



87

FIN 86 - 87* **

3 vie - 3 ways - 3 voies - 3läufig - 3 vías - 3 biegi

L - cm CT	180						200						220					
	A	B	C	D	E	F	A	B	C	D	E	F	A	B	C	D	E	F
160	C - cm																	
180	C - cm																	
200	C - cm																	
220	C - cm																	
240	C - cm																	
260	C - cm																	
280	C - cm																	
300	C - cm																	
320	C - cm																	
LP - cm	66						72						78					

L - cm CT	240						260						280					
	A	B	C	D	E	F	A	B	C	D	E	F	A	B	C	D	E	F
160	C - cm																	
180	C - cm																	
200	C - cm																	
220	C - cm																	
240	C - cm																	
260	C - cm																	
280	C - cm																	
300	C - cm																	
320	C - cm																	
LP - cm	86						92						100					

L - cm CT	300						320						340					
	A	B	C	D	E	F	A	B	C	D	E	F	A	B	C	D	E	F
160	C - cm																	
180	C - cm																	
200	C - cm																	
220	C - cm																	
240	C - cm																	
260	C - cm																	
280	C - cm																	
300	C - cm																	
320	C - cm																	
LP - cm	106						112						120					

* I prezzi dei sistemi completi sono riferiti a tessuti nella stessa variante colore. Non è compreso l'allineamento dell'eventuale disegno del tessuto.
 The prices of the complete systems are referred to fabrics in the same colour variant. The alignment of any drawing of the fabric is not included.
 Les prix des systèmes complets se réfèrent aux tissus dans la même variante de coloris. L'éventuel alignement du dessin de la toile n'est pas inclus.
 Die Preise der Komplettsysteme beziehen sich auf die Stoffe in der gleichen Farbvariante. Eine eventuelle Anpassung des Stoffdesigns ist nicht enthalten.
 Los precios de los sistemas completos se refieren a telas en la misma variante de color. La alineación del dibujo del tejido no está incluida.
 Ceny kompletnych systemów odnoszą się do tkanin w tym samym wariantcie kolorystycznym. Cena nie uwzględnia ewentualnego wyrównania wzorów tkanin.

** Terminali in ABS e peso interno 40x4mm - Finales in ABS and internal weight 40x4mm - Embouts en ABS et lestage interne 40x4mm
 Endkappe aus ABS und Innenbeschwerung 40x4mm - Tapones en ABS y contrapeso interior 40x4mm - Zatyczka ABS i obciążnik wewnętrzny 40x4mm

Maggiorazioni - Surcharges - Suppléments - Zuschläge - Suplementos - Dodatkowa opłata

L - cm	180	200	220	240	260	280	300	320	340
86 - 87***									

*** Terminali e peso esterno da 25mm in alluminio - Finales and external weight 25mm in aluminium - Embouts et lestage 25mm en aluminium
 Endkappe und Aussenbeschwerung 25mm aus Aluminium - Tapones y contrapeso exterior 25mm en aluminio - Zatyczka i obciążnik zewnętrzny 25 mm z aluminium

Movimento a corda - Corded systems - Tirage - Schnurbedienung - Movimiento de cuerda - Koszt mechanizmu

L - cm	180	200	220	240	260	280	300	320	340
86 - 87									

FIN = Finitura - Finish - Finition - Fertigung - Acabado - Wykończenie
 L = Larghezza sistema (cm) - System width (cm) - Largeur système (cm) - Gesamtbreite (cm) - Ancho sistema (cm) - Szerokość systemu (cm)
 CT = Classe tessuto - Fabric category - Catégorie tissu - Gewebegruppe - Categoría tejido - Klasa tkaniny
 C = Altezza tessuto (cm) - Fabric height (cm) - Hauteur de la toile (cm) - Stoff Höhe (cm) - Altura tejido (cm) - Wysokość tkaniny (cm)
 LP = Larghezza pannello (cm) - Panel width (cm) - Largeur panneau (cm) - Paneelebreite (cm) - Ancho panel (cm) - Szerokość panelu (cm)

FIN 86 - 87**

4 vie - 4 ways - 4 voies - 4läufig - 4 vías - 4 biegi

L - cm CT	260						280						300					
	A	B	C	D	E	F	A	B	C	D	E	F	A	B	C	D	E	F
160																		
180																		
200																		
220																		
240																		
260																		
280																		
300																		
320																		
LP - cm	70						76						80					

L - cm CT	320						340						360					
	A	B	C	D	E	F	A	B	C	D	E	F	A	B	C	D	E	F
160																		
180																		
200																		
220																		
240																		
260																		
280																		
300																		
320																		
LP - cm	86						90						96					

L - cm CT	280						400						420					
	A	B	C	D	E	F	A	B	C	D	E	F	A	B	C	D	E	F
160																		
180																		
200																		
220																		
240																		
260																		
280																		
300																		
320																		
LP - cm	96						106						110					

* I prezzi dei sistemi completi sono riferiti a tessuti nella stessa variante colore. Non è compreso l'allineamento dell'eventuale disegno del tessuto.
 The prices of the complete systems are referred to fabrics in the same colour variant. The alignment of any drawing of the fabric is not included.
 Les prix des systèmes complets se réfèrent aux tissus dans la même variante de coloris. L'éventuel alignement du dessin de la toile n'est pas inclus.
 Die Preise der Komplettsysteme beziehen sich auf die Stoffe in der gleichen Farbvariante. Eine eventuelle Anpassung des Stoffdesigns ist nicht enthalten.
 Los precios de los sistemas completos se refieren a telas en la misma variante de color. La alineación del dibujo del tejido no está incluida.
 Ceny kompletnych systemów odnoszą się do tkanin w tym samym wariancie kolorystycznym. Cena nie uwzględnia ewentualnego wyrównania wzorów tkanin.

** Terminali in ABS e peso interno 40x4mm - Finales in ABS and internal weight 40x4mm - Embouts en ABS et lestage interne 40x4mm
 Endkappe aus ABS und Innenbeschwerung 40x4mm - Tapones en ABS y contrapeso interior 40x4mm - Zatyczka ABS i obciążnik wewnętrzny 40x4mm

Maggiorazioni - Surcharges - Suppléments - Zuschläge - Suplementos - Dodatkowa opłata

L - cm	260	280	300	320	340	360	380	400	420
86 - 87***									

*** Terminali e peso esterno da 25mm in alluminio - Finales and external weight 25mm in aluminium - Embouts et lestage 25mm en aluminium
 Endkappe und Aussenbeschwerung 25mm aus Aluminium - Tapones y contrapeso exterior 25mm en aluminio - Zatyczka i obciążnik zewnętrzny 25 mm z aluminium

Movimento a corda - Corded systems - Tirage - Schnurbedienung - Movimiento de cuerda - Koszt mechanizmu

L - cm	260	280	300	320	340	360	380	400	420
86 - 87									

FIN = Finitura - Finish - Finition - Fertigung - Acabado - Wykończenie
 L = Larghezza sistema (cm) - System width (cm) - Largeur système (cm) - Gesamtbreite (cm) - Ancho sistema (cm) - Szerokość systemu (cm)
 CT = Classe tessuto - Fabric category - Catégorie tissu - Gewebegruppe - Categoría tejido - Klasa tkaniny
 C = Altezza tessuto (cm) - Fabric height (cm) - Hauteur de la toile (cm) - Stoff Höhe (cm) - Altura tejido (cm) - Wysokość tkaniny (cm)
 LP = Larghezza pannello (cm) - Panel width (cm) - Largeur panneau (cm) - Paneelebreite (cm) - Ancho panel (cm) - Szerokość panelu (cm)

FIN 86 - 87* **

5 vie - 5 ways - 5 voies - 5läufig - 5 vías - 5 biegi

L - cm CT	340						360						380					
	A	B	C	D	E	F	A	B	C	D	E	F	A	B	C	D	E	F
160																		
180																		
200																		
220																		
240																		
260																		
280																		
300																		
320																		
LP - cm	74						78						82					

L - cm CT	400						420						440					
	A	B	C	D	E	F	A	B	C	D	E	F	A	B	C	D	E	F
160																		
180																		
200																		
220																		
240																		
260																		
280																		
300																		
320																		
LP - cm	86						92						94					

L - cm CT	460						480						500					
	A	B	C	D	E	F	A	B	C	D	E	F	A	B	C	D	E	F
160																		
180																		
200																		
220																		
240																		
260																		
280																		
300																		
320																		
LP - cm	98						102						106					

* I prezzi dei sistemi completi sono riferiti a tessuti nella stessa variante colore. Non è compreso l'allineamento dell'eventuale disegno del tessuto.
 The prices of the complete systems are referred to fabrics in the same colour variant. The alignment of any drawing of the fabric is not included.
 Les prix des systèmes complets se réfèrent aux tissus dans la même variante de coloris. L'éventuel alignement du dessin de la toile n'est pas inclus.
 Die Preise der Komplettsysteme beziehen sich auf die Stoffe in der gleichen Farbvariante. Eine eventuelle Anpassung des Stoffdesigns ist nicht enthalten.
 Los precios de los sistemas completos se refieren a telas en la misma variante de color. La alineación del dibujo del tejido no está incluida.
 Ceny kompletnych systemów odnoszą się do tkanin w tym samym wariantcie kolorystycznym. Cena nie uwzględnia ewentualnego wyrównania wzorów tkanin.

** Terminali in ABS e peso interno 40x4mm - Finales in ABS and internal weight 40x4mm - Embouts en ABS et lestage interne 40x4mm
 Endkappe aus ABS und Innenbeschwerung 40x4mm - Tapones en ABS y contrapeso interior 40x4mm - Zatyczka ABS i obciążnik wewnętrzny 40x4mm

Maggiorazioni - Surcharges - Suppléments - Zuschläge - Suplementos - Dodatkowa opłata

L - cm	340	360	380	400	420	440	460	480	500
86 - 87***									

*** Terminali e peso esterno da 25mm in alluminio - Finales and external weight 25mm in aluminium - Embouts et lestage 25mm en aluminium
 Endkappe und Aussenbeschwerung 25mm aus Aluminium - Tapones y contrapeso exterior 25mm en aluminio - Zatyczka i obciążnik zewnętrzny 25 mm z aluminium

Movimento a corda - Corded systems - Tirage - Schnurbedienung - Movimiento de cuerda - Koszt mechanizmu

L - cm	340	360	380	400	420	440	460	480	500
86 - 87									

FIN = Finitura - Finish - Finition - Fertigung - Acabado - Wykończenie
 L = Larghezza sistema (cm) - System width (cm) - Largeur système (cm) - Gesamtbreite (cm) - Ancho sistema (cm) - Szerokość systemu (cm)
 CT = Classe tessuto - Fabric category - Catégorie tissu - Gewebegruppe - Categoría tejido - Klasa tkaniny
 C = Altezza tessuto (cm) - Fabric height (cm) - Hauteur de la toile (cm) - Stoff Höhe (cm) - Altura tejido (cm) - Wysokość tkaniny (cm)
 LP = Larghezza pannello (cm) - Panel width (cm) - Largeur panneau (cm) - Paneelebreite (cm) - Ancho panel (cm) - Szerokość panelu (cm)

INDUS

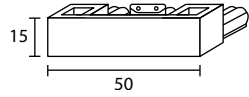

373045

Tappo strappo
Simple endcap
Bouchon simple
Endkappe
Tapón simple
Zatyczka

373055

Tappo ritorno corda
Endcap return pulley
Bouchon contrepoulie
Rückschnurkappe
Tapón contrapolea
Zatyczka do sznurka

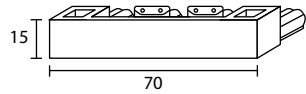

473045

Tappo strappo
Simple endcap
Bouchon simple
Endkappe
Tapón simple
Zatyczka

473055

Tappo ritorno corda
Endcap return pulley
Bouchon contrepoulie
Rückschnurkappe
Tapón contrapolea
Zatyczka do sznurka

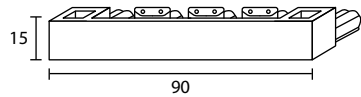

573045

Tappo strappo
Simple endcap
Bouchon simple
Endkappe
Tapón simple
Zatyczka

573055

Tappo ritorno corda
Endcap return pulley
Bouchon contrepoulie
Rückschnurkappe
Tapón contrapolea
Zatyczka do sznurka

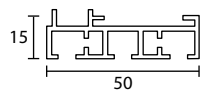

373300

Binario
Track
Rail

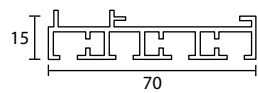

473400

Schiene
Riel
Tor

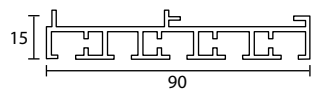

573500

Binario
Track
Rail

Schiene
Riel
Tor

Vie = Vie - Ways - Voies - Schiene - Vías - Biegi

Cod.		373045	373055
FIN	Vie	3	3
86 - 87	ABS		

Cod.		473045	473055
FIN	Vie	4	4
86 - 87	ABS		

Cod.		573045	573055
FIN	Vie	5	5
86 - 87	ABS		

Cod.		373300	473400
FIN	Vie	3	4
86 - 87			

Cod.		573500
FIN	Vie	5
86 - 87	ABS	

INDUS

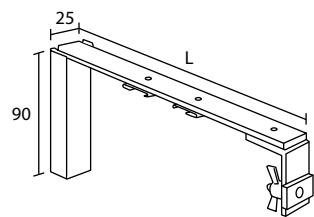

5533--

Supporto doppio con cover
Double bracket with cover
Support double avec couverture
Doppelträger mit Deckel
Soporte doble con cover
Wspornik podwójny z nakładką

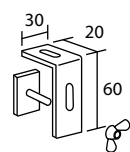

853018

Supporto a soffitto
Ceiling bracket
Support à plafond
Deckenträger
Soporte a techo
Wspornik do sufitu

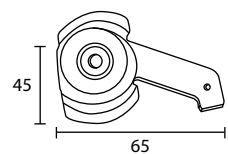

373998

Supporto a soffitto
Ceiling bracket
Support à plafond

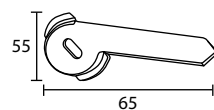

573998

Deckenträger
Soporte a techo
Wspornik do sufitu

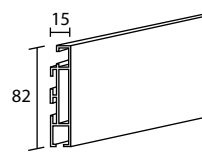

853300

Profilo
Profile
Profil
Profil
Perfil
Profil

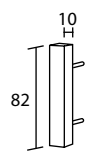

853311

Tappo
Endcap
Bouchon
Endkappe
Tapón
Zatyczka

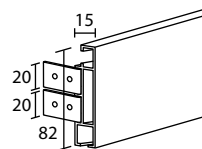

8230--

Angolare
Angle
Retour
Kante
Ángulo
Narozny

Vie = Vie - Ways - Voies - Schiene - Vías - Biegi

Cod.		553309	553319	553329
FIN	L - mm	90	160	210
86 - 87				

Cod.		853018
FIN		
86 - 87		

Cod.		373998	573998
FIN	Vie	3 - 4	5

COMPONENTI - COMPONENTS - COMPOSANTS - ZUBEHÖR - COMPONENTES - CZĘŚCI

Cod.		853300	853311
FIN	L - mt	1	
86 - 87			

Cod.		823002SX / DX	823003SX / DX	823004SX / DX
FIN	L - mt	110	180	230
86 - 87				

INDUS

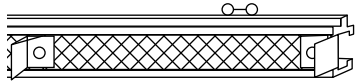

303090

Profilo velcrato con traini e supporti scorrevoli
Velcro bar with sliding rings and tracks
Profil de velcro avec glisseurs et entraineurs
Panelwagen inkl. Klettband
Barra velcrada con correderas y remolques
Profil na rzep z podporami i linką przesuwną

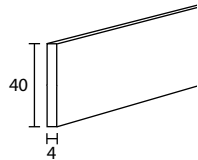

403190

Peso interno
Internal weight
Barre de lestage interne

Interne Beschwerungsprofil
Perfil contrapeso interior
Obciążnik wewnętrzny

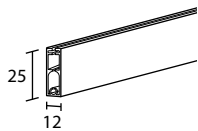

253120

Peso
Weight bar
Barre de lestage
Beschwerungsprofil
Perfil contrapeso
Obciążnik



253135

Tappo per peso
Endcap for weight bar
Bouchon pour barre de lestage
Endkappe Für Beschwerungsprofil
Tapón para contrapeso
Zaślepka obciążnika

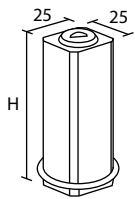

5630--

Fiocco piatto
Flat weight
Contrepoids plat

Schnurbeschwerer
Contrapeso plano
Obciążnik płaski

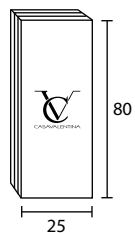

513099

Maniglia
Handle
Poignée
Klinke
Manivela
Raczka

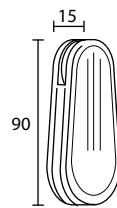

5010

Fiocco in plastica ABS
Plastic cord weight
Contrepoids en plastique
Schnurbeschwerer aus "ABS"
Contrapeso de plástico
Obciążnik plastikowy

COMPONENTI - COMPONENTS - COMPOSANTS - ZUBEHÖR - COMPONENTES - CZĘŚCI

Cod.		303090	
FIN	L - mt	1	

Cod.		403190	
FIN	L - mt	1	

Cod.		253120	253135
FIN	L - mt	1	
86 - 87			

Cod.		563007	563008
FIN	H - mm	80	100
86 - 87			

Cod.		513099	5010
FIN			
86 - 87			