

Cod. 973A19...SX / DX

Sistema a parete  
Wall system

Système de face  
Wandmontage

Sistema pared  
System ścienny

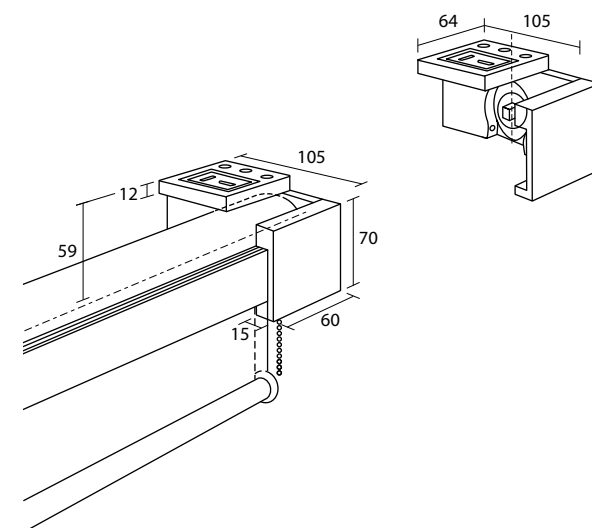
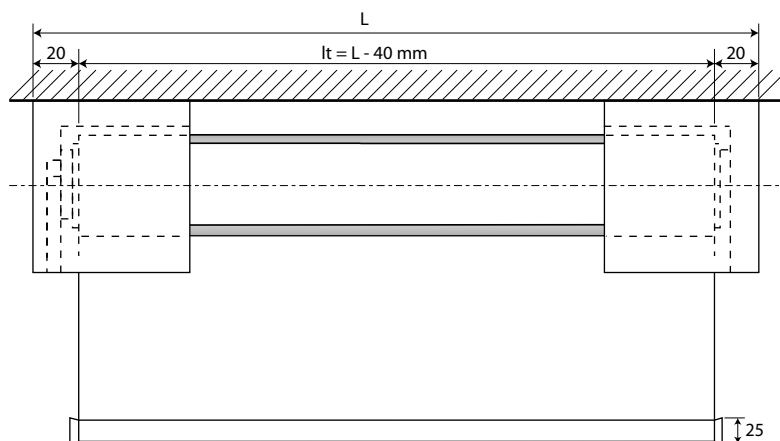

Cod. 973T29...SX / DX

Sistema a soffitto  
Ceiling system

Système plafond  
Deckenmontage

Sistema techo  
System sufitowy



18



25



65



67



312



FIN 18 - 25 - 312

Supporti - Brackets - Supports - Träger - Soportes - Wsporniki Cod. 823419 - 823429

L - cm CT	80			100			120		
	D	E	F	D	E	F	D	E	F
120									
140									
160									
180									
200									
220									
240									
260									
280									
300									

L - cm CT	140			160		
	D	E	F	D	E	F
120						
140						
160						
180						
200						
220						
240						
260						
280						
300						

Maggiorazioni - Surcharges - Suppléments - Zuschläge - Suplementos - Dodatkowa opłata

L - cm	80	100	120	140	160
65 - 67					

FIN = Finitura - Finish - Finition - Fertigung - Acabado - Wykończenie

L = Larghezza sistema (cm) - System width (cm) - Largeur système (cm) - Gesamt Breite - Ancho sistema (cm) - Szerokość systemu (cm)

CT = Classe tessuto - Classe tessuto - Classe tessuto - Classe tessuto - Classe tessuto - Classe tessuto

C = Altezza tessuto (cm) - Fabric width (cm) - Hauteur de la toile (cm) - Stoff Höhe (cm) - Altura tejido (cm) - Wysokość tkaniny (cm)

# GALATEA

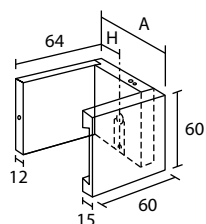

8234-- 973418 N&D

Lato perno  
Pivot side  
Côté pivot

Träger Achseseite  
Lado pivote  
Strona czopa

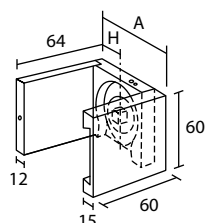

8234-- 973419 N&D

Lato catena  
Chain side  
Côté chainette

Träger Ketteseite  
Lado cadena  
Strona łańcuszka

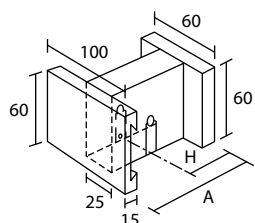

823614 973419 N&D

Intermedio P/P  
Middle P/P  
Intermédiaire P/P  
Mittelträger P/P  
Intermedio P/P  
Środkowy P/P

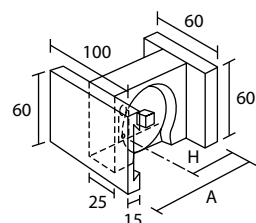

823615 973615 N&D

Intermedio P/C  
Middle P/C  
Intermédiaire P/C  
Mittelträger P/C  
Intermedio P/C  
Środkowy P/C

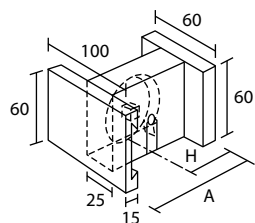

823616 973616 N&D

Intermedio C/P  
Middle C/P  
Intermédiaire C/P  
Mittelträger C/P  
Intermedio C/P  
Środkowy C/P

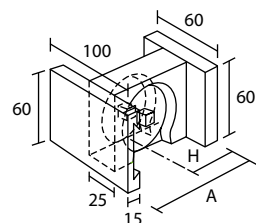

823617 973617 N&D

Intermedio C/C  
Middle C/C  
Intermédiaire C/C  
Mittelträger C/C  
Intermedio C/C  
Środkowy C/C

P = Lato perno - Pivot side - Côté pivot - Achseseite - Lado Pivote - Strona czopa  
C = Lato catena - Chain side - Côté chainette - Ketteseite - Lado cadena - Strona łańcuszka

SISTEMA A PARETE - WALL SYSTEM - SYSTÈME DE FACE - WANDMONTAGE - SISTEMA PARED - SYSTEM ŚCIENNY

Cod.		823418SX / DX	823438SX / DX	973418SX / DX N&D
FIN	A - mm	90	140	125
	H - mm	45	95	55
	18 - 25 - 312			
	65 - 67			

Cod.		823419SX / DX	823439SX / DX	973419SX / DX N&D
FIN	A - mm	90	140	125
	H - mm	45	95	55
	18 - 25 - 312			
	65 - 67			

Cod.		823614SX / DX	973614SX / DX N&D	823615SX / DX	973615SX / DX N&D
FIN	A - mm	90	125	90	125
	H - mm	45	55	45	55
	18 - 25 - 312				
	65 - 67				

Cod.		823616SX / DX	973616SX / DX N&D	823617SX / DX	973617SX / DX N&D
FIN	A - mm	90	125	90	125
	H - mm	45	55	45	55
	18 - 25 - 312				
	65 - 67				

# GALATEA

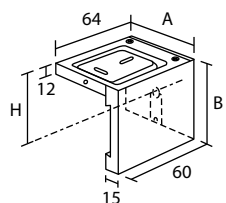

823428 973428 N&D

Lato perno  
Pivot side  
Côté pivot

Träger Achseseite  
Lado pivote  
Strona czopa

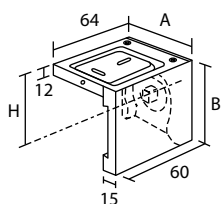

823429 923429 N&D

Lato catena  
Chain side  
Côté chainette

Träger Ketteseite  
Lado cadena  
Strona łańcuszka

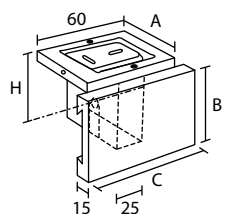

823624 973624 N&D

Intermedio P/P  
Middle P/P  
Intermédiaire P/P  
Mittelträger P/P  
Intermedio P/P  
Środkowy P/P

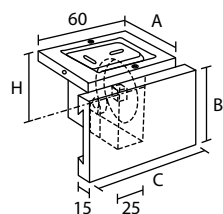

823625 973625 N&D

Intermedio P/C  
Middle P/C  
Intermédiaire P/C  
Mittelträger P/C  
Intermedio P/C  
Środkowy P/C

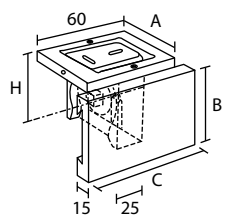

823626 973626 N&D

Intermedio C/P  
Middle C/P  
Intermédiaire C/P  
Mittelträger C/P  
Intermedio C/P  
Środkowy C/P

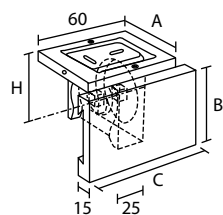

823627 973627 N&D

Intermedio C/C  
Middle C/C  
Intermédiaire C/C  
Mittelträger C/C  
Intermedio C/C  
Środkowy C/C

P = Lato perno - Pivot side - Côté pivot - Achseseite - Lado Pivote - Strona czopa  
C = Lato catena - Chain side - Côté chainette - Ketteseite - Lado cadena - Strona łańcuszka

SISTEMA A SOFFITTO - CEILING SYSTEM - SYSTÈME PLAFOND - DECKENMONTAGE - SISTEMATECHO - SYSTEM SUFITOWY

Cod.		823428SX / DX	973428SX / DX N&D
FIN	A - mm	75	105
	B - mm	75	82
	H - mm	45	59
18 - 25 - 312			
65 - 67			

Cod.		823429SX / DX	973429SX / DX N&D
FIN	A - mm	75	105
	B - mm	75	82
	H - mm	45	59
18 - 25 - 312			
65 - 67			

Cod.		823624	973624 N&D	823625	973625 N&D
FIN	A - mm	75	105	75	105
	B - mm	75	82	75	82
	C - mm	90	100	90	100
	H - mm	45	59	45	59
18 - 25 - 312					
66 - 67					

Cod.		823626	973626 N&D	823627	973627 N&D
FIN	A - mm	75	105	75	105
	B - mm	75	82	75	82
	C - mm	90	100	90	100
	H - mm	45	59	45	59
18 - 25 - 312					
66 - 67					

# GALATEA

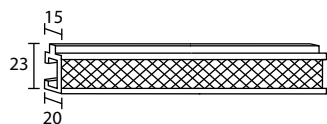

4030

Profilo velcrato  
Velcro profile  
Profil velcro

Profil mit klettband  
Perfil velcrado  
Profil z rzepem



973303

Agganci  
Hooks  
Crochets

Befestigungshaken  
Enganches  
Haczyki

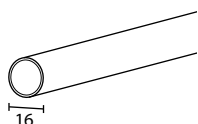

164100

Peso  
Weight bar  
Barre de lestage

Beschwerungsprofil  
Perfil contrapeso  
Obciążnik



163055

Tappo per peso  
Endcap for weight bar  
Bouchon pour barre de lestage  
Endkappe Für Beschwerungsprofil  
Tapón para contrapeso  
Zasleпка obciążnika

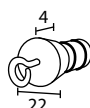

163245

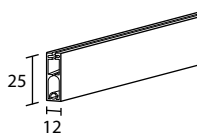

253120

Peso  
Weight bar  
Barre de lestage  
Beschwerungsprofil  
Perfil contrapeso  
Obciążnik



253135

Tappo per peso  
Endcap for weight bar  
Bouchon pour barre de lestage  
Endkappe Für Beschwerungsprofil  
Tapón para contrapeso  
Zasleпка obciążnika

COMPONENTI - COMPONENTS - COMPOSANTS - ZUBEHÖR - COMPONENTES - CZĘŚCI

<b>Cod.</b>		<b>4030</b>
<b>FIN</b>	<b>L - mt</b>	<b>1</b>
<b>25</b>		

<b>Cod.</b>		<b>973303</b>
<b>FIN</b>		
<b>25</b>		

<b>Cod.</b>		<b>164100</b>
<b>FIN</b>	<b>L - mt</b>	<b>1</b>
<b>18 - 25 - 312</b>		
<b>65 - 67</b>		

<b>Cod.</b>	<b>163055</b>	<b>163245</b>
<b>FIN</b>		
<b>18 - 25 - 312</b>		
<b>65 - 67</b>		

<b>Cod.</b>	<b>253120</b>	<b>253135</b>
<b>FIN</b>	<b>L - mt</b>	<b>1</b>
<b>18 - 25 - 312</b>		
<b>65 - 67</b>		